



---

---

AIM & THURLBY THANDAR INSTRUMENTS

MX100T & MX100TP

---

---

Triple Output Multi-Range DC Power Supply

INSTRUCTION MANUAL

Aim-TTi

# CONTENTS

<b>1</b>	<b>Using this Manual .....</b>	<b>3</b>
<b>2</b>	<b>Product Description.....</b>	<b>4</b>
<b>3</b>	<b>Safety .....</b>	<b>5</b>
<b>4</b>	<b>Installation .....</b>	<b>6</b>
4.1	Mains Operating Voltage .....	6
4.2	Mains Lead.....	6
4.3	Mounting.....	6
4.4	Ventilation.....	6
<b>5</b>	<b>Connections .....</b>	<b>7</b>
5.1	Front Panel Connections .....	7
5.2	Rear Panel Connections (MX100TP) .....	7
5.3	Terminal Voltages and Safety.....	7
5.4	Output Protection.....	7
<b>6</b>	<b>Initial Operation.....</b>	<b>8</b>
6.1	AC Power On/Off.....	8
6.2	DC Output On/Off .....	8
<b>7</b>	<b>The Display and Soft Key Control .....</b>	<b>9</b>
7.1	The Home Screen .....	9
7.2	Individual Output Screens .....	9
7.3	Setting with the Keypad.....	10
7.4	Setting with the Spin Wheel.....	10
7.4.1	Spin Wheel Action Options .....	10
<b>8</b>	<b>Power Supply Settings .....</b>	<b>11</b>
8.1	CV and CC modes, Viewing Settings (Limits).....	11
8.2	Setting with Individual Output Screens .....	11
8.3	Power Display (VxA).....	12
8.4	Selecting Current Meter Averaging.....	12
8.5	Setting Over-Voltage and Over-Current protection.....	12
8.6	Setting the Voltage/Current Range.....	13
8.7	Store and Recall of Settings .....	13
8.8	The System Menu Screen .....	14
8.9	Voltage Tracking.....	14
8.10	Locking the Front Panel .....	14
<b>9</b>	<b>Display Symbols .....</b>	<b>15</b>
<b>10</b>	<b>Menu - Advanced Functions .....</b>	<b>16</b>
10.1	Setting Voltage Tracking .....	16
10.2	Current Meter Averaging Setup.....	17
10.3	Store and Recall of Settings for All Outputs .....	17
10.4	Multi-On / Multi-Off Operation and Sequencing.....	17
10.4.1	Emergency Off .....	18
10.5	Pass Code Locking of the Front Panel .....	18
10.6	System Preferences .....	19
10.7	Setting to Factory Defaults .....	19
10.8	Adjusting LCD Contrast.....	19
10.9	Calibration .....	19
10.10	Remote Control Interfaces (MX100TP only).....	19

<b>11</b>	<b>Changing System Preferences</b> .....	<b>20</b>
11.1	Status at Power-up .....	20
11.2	Alert Sound (Beep) .....	20
11.3	Spin Wheel Action .....	20
<b>12</b>	<b>Notes on Operation</b> .....	<b>21</b>
12.1	Accuracy and Resolution .....	21
12.2	Remote Sense .....	21
12.3	Parallel Wiring of Outputs .....	21
12.4	Series Wiring of Outputs .....	22
12.5	Instantaneous Current Output .....	22
12.6	Output On/Off and Response Speed .....	22
12.7	Using OVP and OCP .....	23
12.7.1	OCP Trip at Output On .....	23
12.8	Over-temperature Trip (OTP) .....	23
<b>13</b>	<b>Remote Interface Operation (MX100TP only)</b> .....	<b>24</b>
13.1	MX100TP Rear Panel Connections .....	24
13.2	Remote Interface Configuration .....	24
13.2.1	GPIB Interface (optional) .....	25
13.2.2	RS232 Interface .....	25
13.2.3	USB Interface and Device Driver Installation .....	26
13.2.4	LAN Interface .....	26
13.2.5	LAN IP Address and Hostname .....	27
13.2.6	Interface Locking .....	28
13.2.7	Status Reporting .....	29
<b>14</b>	<b>Remote Commands (MX100TP only)</b> .....	<b>34</b>
14.1	General .....	34
14.1.1	Remote and Local Operation .....	34
14.1.2	Remote Command Handling .....	34
14.1.3	Remote Command Formats .....	34
14.1.4	Command Timing .....	35
14.1.5	Response Formats .....	35
14.2	Command List .....	35
14.2.1	Instrument Function Commands .....	35
14.2.2	Common Commands .....	37
14.2.3	Status Commands .....	38
14.2.4	Interface Management Commands .....	39
<b>15</b>	<b>Maintenance</b> .....	<b>40</b>
15.1	Cleaning .....	40
15.2	Fuse .....	40
15.3	Calibration .....	40
15.4	Firmware Update .....	40
<b>16</b>	<b>Technical Specifications</b> .....	<b>41</b>
<b>17</b>	<b>Default Values</b> .....	<b>44</b>

---

# 1 Using this Manual

This manual includes cross references which are shown as follows - see section X.X.

Within a PDF file, the shaded number is a hyperlink to that section number which enables the user to jump rapidly to the section referred to and then jump back to continue reading the original section.

(N.B. for hyperlink navigation within Acrobat Reader, enable “show all page navigation tools” or use the keyboard shortcuts Alt+Left-Arrow and Alt+Right-Arrow).

The Table of Contents is also fully hyperlinked and is replicated within the Bookmarks pane.

**Note:** The latest revisions of this manual, device drivers and software tools can be downloaded from: <http://www.aimtti.com/support>.

## 2 Product Description

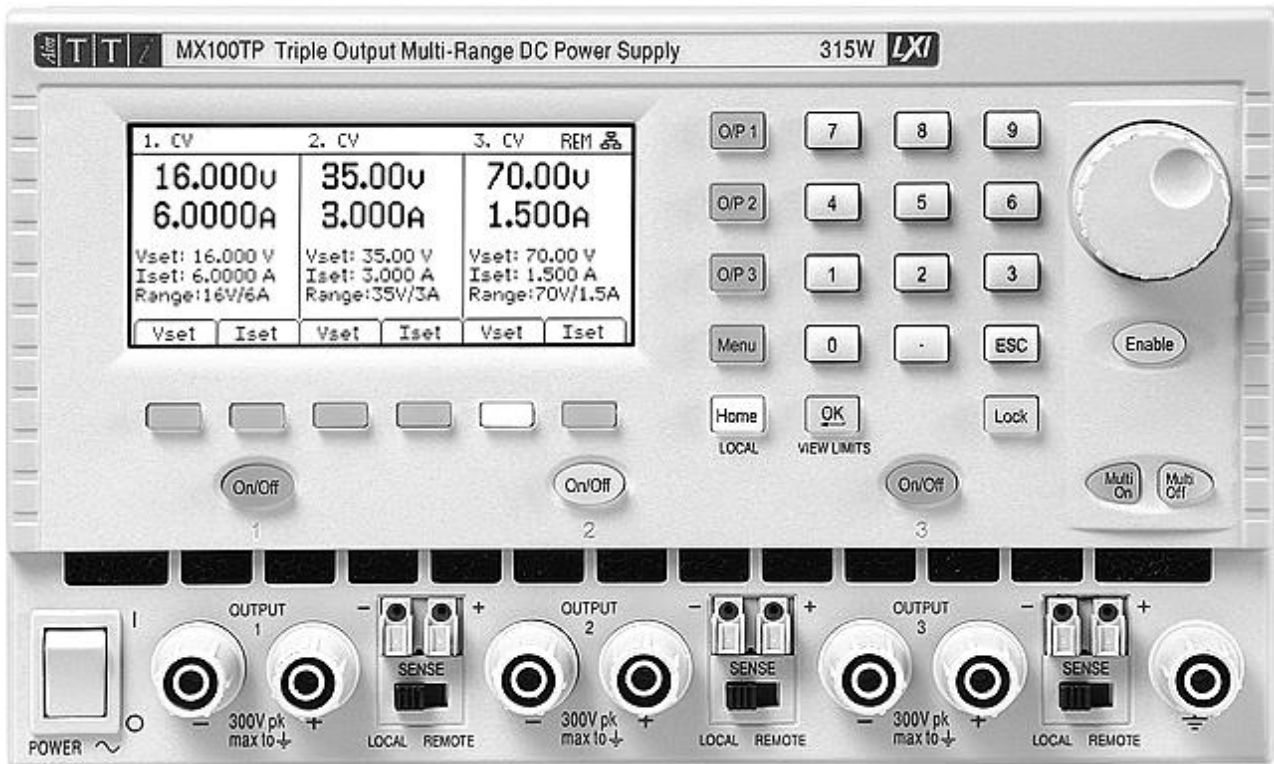

The MX100T is a triple output laboratory power supply incorporating three outputs of similar power and features.

Each output can provide 0 to 35 volts at 0 to 3 amps (105 watts) with range switching extending its capabilities to provide voltages up to 70V and currents up to 6A. Twelve range combinations are available as shown in the chart.

Mixed-mode regulation is used which combines switch-mode power conversion with linear final regulation to give good noise and transient performance.

All information is displayed on a large backlit graphic LCD and control is via soft keys together with a numeric keypad and spin wheel.

Advanced features include 50 settings memories for each output plus 50 further memories that record the settings for all three outputs together.

Multi-On and Multi-Off keys supplement the individual output On/Off keys and can be programmed to turn the outputs on or off in a timed sequence.

The front panel can be locked to prevent accidental changes to settings.

The power supply is housed in a compact half-rack width, 3U high case with front input ventilation. An intelligent fan is used to minimise cooling noise.

The MX100TP has the same manual control features and adds USB, RS232, GPIB (optional) and LXI compliant LAN interfaces together with duplicate power and sense terminals at the rear.

Range Combinations		
Output 1	Output 2	Output 3
35V/3A	35V/3A	35V/3A
35V/3A	16V/6A	35V/3A
35V/3A	35V/3A	70V/1.5A
35V/3A	16V/6A	70V/1.5A
35V/3A	35V/6A	--
35V/3A	--	70V/3A
16V/6A	35V/3A	35V/3A
16V/6A	16V/6A	35V/3A
16V/6A	35V/3A	70V/1.5A
16V/6A	16V/6A	70V/1.5A
16V/6A	35V/6A	--
16V/6A	--	70V/3A

### 3 Safety

This power supply is a Safety Class I instrument according to IEC classification and has been designed to meet the requirements of EN61010-1 (Safety Requirements for Electrical Equipment for Measurement, Control and Laboratory Use). It is an Installation Category II instrument intended for operation from a normal single phase supply.

This instrument has been tested in accordance with EN61010-1 and has been supplied in a safe condition. This instruction manual contains some information and warnings which have to be followed by the user to ensure safe operation and to retain the instrument in a safe condition.

This instrument has been designed for indoor use in a Pollution Degree 2 environment in the temperature range 5°C to 40°C, 20% - 80% RH (non-condensing). It may occasionally be subjected to temperatures between +5°C and -10°C without degradation of its safety. Do not operate while condensation is present.

Use of this instrument in a manner not specified by these instructions may impair the safety protection provided. Do not operate the instrument outside its rated supply voltages or environmental range.

#### **WARNING! THIS INSTRUMENT MUST BE EARTHED**

Any interruption of the mains earth conductor inside or outside the instrument will make the instrument dangerous. Intentional interruption is prohibited. The protective action must not be negated by the use of an extension cord without a protective conductor.

When the instrument is connected to its supply, terminals may be live and opening the covers or removal of parts (except those to which access can be gained by hand) is likely to expose live parts. The apparatus shall be disconnected from all voltage sources before it is opened for any adjustment, replacement, maintenance or repair. Capacitors inside the power supply may still be charged even if the power supply has been disconnected from all voltage sources but will be safely discharged about 10 minutes after switching off power.

Any adjustment, maintenance and repair of the opened instrument under voltage shall be avoided as far as possible and, if inevitable, shall be carried out only by a skilled person who is aware of the hazard involved.

If the instrument is clearly defective, has been subject to mechanical damage, excessive moisture or chemical corrosion the safety protection may be impaired and the apparatus should be withdrawn from use and returned for checking and repair.

Make sure that only fuses with the required rated current and of the specified type are used for replacement. The use of makeshift fuses and the short-circuiting of fuse holders is prohibited.

Do not wet the instrument when cleaning it.

The following symbols are used on the instrument and in this manual:-



meaning **Caution**. In this manual this symbol is used to highlight situations where incorrect use may either damage the instrument or cause a potential hazard to the user.



Earth (ground) terminal.



mains supply OFF.



mains supply ON.



alternating current (ac)

---

## 4 Installation

### 4.1 Mains Operating Voltage

This instrument has a universal input range and will operate from a nominal 115V or 230V mains supply without adjustment. Check that the local supply meets the AC Input requirement given in the Specification see section 16.

### 4.2 Mains Lead

Connect the instrument to the AC supply using the mains lead provided. Should a mains plug be required for a different mains outlet socket, a suitably rated and approved mains lead set should be used which is fitted with the required wall plug and an IEC60320 C13 connector for the instrument end. To determine the minimum current rating of the lead-set for the intended AC supply, refer to the power rating information on the equipment or in the Specification.

**WARNING! THIS INSTRUMENT MUST BE EARTHED.**

Any interruption of the mains earth conductor inside or outside the instrument will make the instrument dangerous. Intentional interruption is prohibited.

### 4.3 Mounting

This instrument is suitable both for bench use and rack mounting. It is delivered with feet for bench mounting. The front feet include a tilt mechanism for optimal panel angle.

A rack kit for mounting in a 19" rack is available from the manufacturers, or their agents and distributors overseas.

### 4.4 Ventilation

The power supply is cooled by an intelligent multi-speed fan which vents at the rear. Cooling air is drawn in through slots in the front panel directly above the terminals, and by slots in the base of the unit close to the front.

In a rack-mounted situation no additional space is required above or to the sides of the unit. Some air space below the unit will ensure the best possible airflow and the lowest fan speeds for a given power, but is not required.

Ensure that the ventilation slots and rear fan exhaust are not obstructed. In the event of overheating, a temperature trip will turn all of the outputs off – see section 12.8.

---

## 5 Connections

### 5.1 Front Panel Connections

For each output, the load should be connected to the positive (red) and negative (black) terminals marked OUTPUT.

Both are fully floating and either can be connected to ground or to a terminal of another output.

Remote sense connections to the load, if required, are made from the positive (+) and negative (-) SENSE terminals. Switch the SENSE switch to REMOTE when remote sensing is required. Switch back to LOCAL when remote sensing is not in use. See section 12.2 for more information.



The grey terminal marked with an Earth symbol is connected to the chassis and safety earth ground.

### 5.2 Rear Panel Connections (MX100TP)

The MX100T has only an AC power connection socket on the rear panel. The MX100TP has duplicate power and sense terminals on the rear panel and offers full remote-control capabilities through USB, RS232, GPIB (optional) and LAN interfaces.

All interfaces are fully isolated from the power supply output terminals. USB, RS232 and GPIB (optional) interfaces are connected to chassis ground. The LAN interface is isolated by standard network transformers.

Rear connections for the MX100TP are detailed in section 13.1.

### 5.3 Terminal Voltages and Safety

The outputs of the power supply are fully floating and may be connected to other equipment resulting in the voltage appearing at a terminal being greater than the output voltage alone.



The maximum permissible voltage between any terminal and earth ground () is 300VDC; the maximum permissible voltage between either terminal of one output and either terminal of another output on the same power supply is also 300VDC.

**WARNING!** Such voltages are exceedingly hazardous and great care should be taken by the user. The front terminals are intrinsically touch proof, but hazard may still exist depending upon the type of connection made to the terminal. On no account should the connections be touched under such use.



For the MX100TP only, voltages appearing on the front terminals will also appear on the rear terminals. The rear terminals have protective walls but are not intrinsically touch proof, and additional precautions must be taken if voltages above 70 volts DC could be present.

If any hazardous voltages could exist, all connections to the front or rear terminals must be made with the power switched off on all voltage sources.

### 5.4 Output Protection

Each output is protected against the application of external forward voltages up to 50 volts (outputs 1 and 2) and 90 volts (output 3). Each output is protected against the application of reverse voltages by a clamp diode with a maximum continuous current capability of 3 amps.

Further protection is provided by OVP and OCP trips and an over-temperature trip.



---

## 6 Initial Operation

### 6.1 AC Power On/Off

#### Power ~ O/I

The AC power switch is located at the bottom left of the front panel.

At power-up a screen is displayed that shows the firmware revision number and a brief description of the starting conditions. These can be changed from System Preferences if required – see section 11.1.

### 6.2 DC Output On/Off

#### On/Off

Each output has its own DC On/Off key. These are positioned directly above each set of output terminals and are numbered 1, 2 and 3 from left to right. Alternate presses of the key turns the output on or off. The on state is indicated by the key being illuminated in red.



At power-up the default behaviour is for all the outputs to be set to off. However, the user can change this default setting such that the outputs are restored to their condition when the instrument was switched off. This change is made from System Preferences - see section 11.1.

#### Multi-On / Multi-Off

It is also possible to turn all three outputs on or off simultaneously using the Multi-On and Multi-Off keys. By default these keys operate on all three outputs simultaneously but the behaviour can be changed to turn the outputs on or off in a timed sequence or to remove an output from either Multi-On or Multi-Off control, see section 10.4.



## 7 The Display and Soft Key Control



With the exception of output On/Off, the primary control of the power supply is via the six keys directly below the display. These are referred to as “soft keys” because their function is not fixed but is annotated by legends on the display directly above.



The function of the keys depends upon the type of screen selected. There are five main screens which are selected by the keys to the right of the display. The selected key is illuminated.

The main screen (Home) displays all three outputs simultaneously, the system menu screen (Menu) provides access to advanced functions, and the individual output screens (O/P n) show more detailed information for each individual output.

### 7.1 The Home Screen

The main (Home) screen is selected with the key marked Home and shows the primary information for all three outputs simultaneously whilst enabling voltage and current to be set for any output.

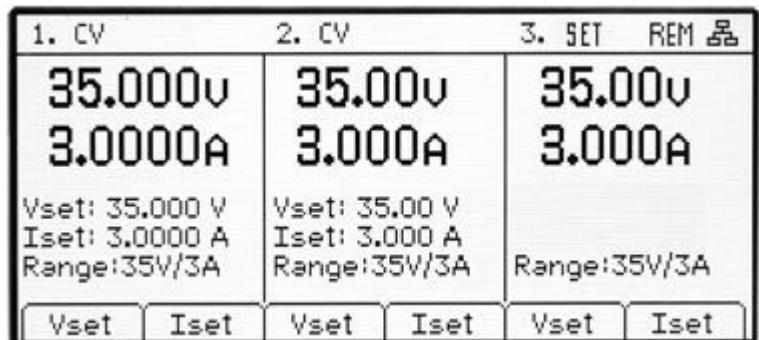

The display is divided into three sections representing outputs 1, 2 and 3 from left to right. For each output the display shows operating mode on the top line as CV (constant voltage), CC (constant current) or SET (Settings). SET is displayed when the output is off.

The two meters directly below show the set values for voltage and current when the output is off, and the voltage and current being supplied to the load when the output is on.

With an output on, the three lines below the meters show the set voltage (Vset), the set current (Iset) and the output range (Range). If the output is off, the Vset and Iset lines do not appear (because the meters are showing the set values).

The six soft keys are used to set voltage (Vset) or current (Iset) for each of the outputs. The presently selected output and parameter (V or I) is indicated by illumination of the soft key and by a flashing arrow in front of the parameter to be adjusted. The user can move freely between setting voltage or current for any output by pressing the appropriate key.

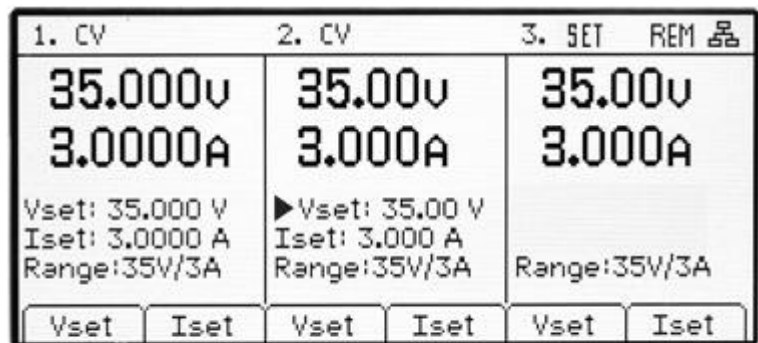

Pressing the same key again or pressing ESC (Escape) cancels the key and disables all setting capability.

### 7.2 Individual Output Screens

Each output has its own display screen selected with the keys O/P 1, O/P 2 and O/P 3. The selected key is illuminated.

These enable additional parameters and functions to be controlled for that output including Range, OVP & OCP, memory store & recall (Stores), and current meter averaging (Iavg). These are detailed within section 8.

## 7.3 Setting with the Keypad

### Vset & Iset

Voltage or current can be set using the numeric keypad.

Upon pressing a numeric key, the OK key will start to flash. When the numeric value entry is completed, pressing OK causes the value to be accepted and actioned. Entry can be abandoned at any point by pressing ESC (Escape). The new value being entered is shown directly below the meters in a smaller font size.



Entry is in volts or amps to a resolution of 0.001 volts and 0.0001 amps for output 1, and 0.01 volts and 0.001 amps for outputs 2 and 3.

Entries need only to be completed as far as the desired digit of resolution, e.g. to enter 5.000 volts it is only necessary to enter 5 followed by OK.

## 7.4 Setting with the Spin Wheel

### Vset & Iset

Voltage or current can alternatively be set using the spin wheel. The wheel is disabled by default but can be enabled by pressing the key below it which toggles its action on or off. When enabled the key is illuminated. The wheel changes the output settings immediately, no OK confirmation is required.

The wheel has a non-linear action. If it is moved slowly the value is incremented in minimum steps (1mV/0.1mA for output 1, or 10mV/1mA for outputs 2 or 3). When the wheel is rotated more rapidly the rate of increment is increased enabling the value to be changed quickly.



### 7.4.1 Spin Wheel Action Options

The action of the spin wheel can be changed from System Preferences to reduce the speed-related increment rate if preferred. Three choices are available: Normal (default), Reduced acceleration, or Single Digit Increment.

Making changes is described in section [11.3](#).

## 8 Power Supply Settings

The procedures for setting voltage and current, either numerically or via the spin wheel, have been explained in the previous section.

### 8.1 CV and CC modes, Viewing Settings (Limits)

Depending upon the load conditions, the actual voltage and actual current applying to the load will not both be equal to their set values.

#### Output On – CV Mode

When in constant voltage mode the output voltage is equal to the set value and CV is shown on the top line of the display. The current setting represents the limiting value of current that could flow (the current limit).

#### Output On – CC Mode

When in constant current mode the output current is equal to the set value and CC is shown on the top line of the display. The voltage setting represents the limiting value of voltage that could be applied (the voltage limit).

Switch-over between CV and CC modes occurs automatically dependent upon the load conditions and the settings. The voltage and current settings may also be described as limits since they represent the maximum values that can apply at the load.

 To draw attention to the CC symbol and make it clear at a glance, a flashing arrow is placed next to it. It is also possible to set an audible alert – see section 11.2.

#### Output Off

When an output is off, the meters show these set values and SET is shown on the top line of the display. When an output is on, the values of voltage generated and current flowing are shown together with CV or CC.

#### View Settings/ View Limits

It is also possible to view the set values for all three outputs at any time. Pressing the OK key (also marked View Limits or View Settings) causes the display to change so that the meters all show the limits values for a period of about 2 seconds.

### 8.2 Setting with Individual Output Screens

The three illuminated keys marked O/P 1, O/P 2 and O/P 3 select a screen that controls only the chosen output. This screen provides more information than the main (Home) screen (see section 7.1), and allows additional parameters to be set.

The top line shows the operating mode (CV, CC or SET) together with the voltage tracking status. The meters are displayed in a larger font, and the complete settings status for the output is shown below them.



Output 1	SET	V Track OFF	REM		
15.898U		5.9435A			
		Vset 15.898V	Iset 5.9435A		
		OVP 40.0 V	VxA 0.000 W		
		OCP 7.000 A	Range 16V/6A		
Vset	Iset	Iavg	OVP/OCP	Range	Stores

The six soft keys are used to set voltage and current (Vset and Iset), over-voltage and over-current protection levels (OVP & OCP), current meter averaging (Iavg), range selection (Range) and store or recall of settings (Stores).

Setting voltage or current is as previously described for the Home screen – see section 7.1.

### 8.3 Power Display (VxA)

The power being supplied to the load (VxA) is displayed in watts on the lower right hand side. The value is calculated from the metered values of voltage and current and is displayed with a maximum resolution of 0.001 watts for output 1 and 0.01 watts for outputs 2 and 3.

### 8.4 Selecting Current Meter Averaging

#### Iavg

Current meter averaging is useful when the load current is varying rapidly. It can help to reduce the variation in the reading and make the display easier to follow.

Selection is done from each individual output screen. Pressing the soft key marked Iavg toggles current meter averaging on or off. The present status is shown in the area above the key and by an asterisk (\* symbol) appearing directly after the current meter. This \* symbol is also displayed on the Home screen.

30.00V  
0.000A\*

Three levels of averaging representing low, medium or high can be selected from the System Menu - see section 10.2. The default value is medium.

### 8.5 Setting Over-Voltage and Over-Current protection

#### OVP/OCP

The power supply offers user adjustable over-voltage protection (OVP) and over-current protection (OCP). If a voltage is detected that exceeds the OVP level, or a current is detected that exceeds the OCP level, the output is switched off and the message OVP or OCP is displayed.

OVP is adjustable between 1V and 40V for outputs 1 and 2, and between 1V and 80V for output 3. OCP is adjustable between 0.01A and 7A for outputs 1 and 2, and between 0.01A and 3.5A for output 3.

Pressing the OVP/OCP soft key creates a new set of soft keys from which OVP & OCP values can be set or turned on or off.

		OVP 40.0 V	VxA 0.00 W
		OCP 7.00 A	Range 16V/6A
OVP Set	OVP OFF	OCP Set	OCP OFF
			OK/Exit

Pressing OVP Set causes the key to illuminate and makes the OVP value settable. A new value can be entered using the numeric keypad or by the spin-wheel if enabled. OVP can be turned off by pressing OVP OFF, and turned back on by pressing OVP On. The previous OVP value is retained when OVP is off and is displayed in brackets.

Similar capabilities are provided for controlling OCP.

Note that, when set to OFF, the function is not completely disabled but is set to the maximum value for the output. Thus if OVP was set to OFF on output 1 and an external voltage greater than 40V was applied to the terminals, an OVP trip would occur.

More information on using OVP and OCP is provided in section 12.7.

## 8.6 Setting the Voltage/Current Range

### Range

Each output has more than one range. For output 1 the choice is 35V/3A or 16V/6A. For output 2 the choice is 35V/3A, 16V/6A or 35V/6A. For output 3 the choice is 35V/3A, 70V/1.5A or 70V/3A.

Note that selecting 35V/6A on output 2 will disable output 3, and selecting 70V/3A on output 3 will disable output 2.

Pressing the Range soft key brings up a menu screen which shows the currently selected range by illumination of the soft key. Pressing another key selects a new range which is actioned when OK/Exit is pressed.

SELECT NEW RANGE					
Old Range: 16V/6A					
New Range: 35V/3A					
35V/3A	16V/6A	35V/6A		Cancel	OK/Exit

Note that a change of range can only be made when the output is off. If the output is on, a message will prompt the user to turn it off.

## 8.7 Store and Recall of Settings

### Stores

Each output has 50 memory stores capable of storing range, voltage, current, OVP and OCP. Pressing the Stores soft key brings up a menu screen which shows the present contents of the memories from which settings can be stored or recalled.

The memories are numbered from 00 to 49 with the currently selected line highlighted. The location can be scrolled using the spin wheel or stepped through using the arrow keys. It is also possible to jump directly to a location by entering a two digit number (e.g. 07 or 45). Unused memory locations are shown by the word Empty.

	Range	Voltage	Current	OVP	OCP
00.	16V/6A	15.00	6.000	40.0	7.00
01.	16V/6A	14.25	6.000	40.0	7.00
02.	16V/6A	11.75	1.250	40.0	7.00
03.	16V/6A	10.50	1.250	40.0	7.00
04.	16V/6A	9.32	1.250	40.0	7.00
05.	16V/6A	8.00	0.250	40.0	7.00
06.	16V/6A	7.75	0.250	40.0	7.00
	Store	Recall	↑	↓	Delete
					Exit

Pressing the Store key writes the present settings of the output into the selected memory location. If the position already has settings stored within it a confirmation is required.

Pressing the Recall key transfers the stored settings of the selected memory location to the output. This happens immediately that the Recall key is pressed. Note that, if the recalled range is different from the present range, the output will be automatically turned off.

The contents of a particular location can be deleted by pressing the Delete soft key. A confirmation is required.

From the Delete confirmation screen it is also possible to delete the contents of all 50 locations by pressing Del All. A confirmation is required.

### Store and Recall for Multiple Outputs

It is also possible to store and recall settings for all three outputs simultaneously. This is described in Advanced Functions section 10.3.

## 8.8 The System Menu Screen

The operation of the System Menu screen is selected with the key marked Menu which illuminates when pressed.

System menu functions are described within section 10 - Advanced Functions.

## 8.9 Voltage Tracking

The power supply can be set-up such that the voltage of output 2 tracks that of output 1, or that output 3 tracks output 2, or that outputs 2 and 3 both track output 1. The tracking status is shown on the top line of the display. Voltage tracking is selected from the System Menu, see section 10.1.

## 8.10 Locking the Front Panel

### Lock

The front panel can be “locked” such that the power supply will not respond to any key presses. This is in order to prevent an accidental changes to settings.





Pressing the Lock key disables the front panel. This is indicated by the key being illuminated in green. Once locked any key press creates a warning message on the display. To unlock the front panel, press and hold the Lock key for more than one second.

For additional security it is also possible to lock the front panel using a pass-code. This is explained in Advanced Functions section 10.5.



## 9 Display Symbols

Some functions are indicated by symbols or abbreviation on the display as follows:





Function	Home Screen	Individual Output Screen
Output on, constant voltage mode	CV shown on the top line next to the output number	CV shown on the top line
Output on, constant current mode	CC shown plus flashing arrow next to the output number	CC shown plus flashing arrow on the top line
Output off	SET shown on the top line next to the output number	SET shown on the top line
Current meter averaging on	* symbol after current meter	* symbol after current meter (and lavg ON in small font)
Voltage tracking	TRK > shown on top line between the Master and Slave	V Track ON or OFF shown on top line plus Master or Slave
Multi-On/Multi-Off not set to defaults (set to Delayed or Never)	Clock symbol on top line next to the mode indication for the affected output 	Clock symbol on top line 
Power supply under remote control (MX100TP only)	REM shown at top right hand side	REM shown at top right hand side
LAN connection status (MX100TP only)	LAN symbol  shown at top right hand side. (see note)	LAN symbol  shown at top right hand side (see note)

Note that the LAN symbol changes to reflect the connection status. This is detailed within the Remote Control pages - see section [13.2.4](#).

The example screen opposite shows output 1 in constant current (CC) mode, output 2 in constant voltage (CV) mode and output 3 showing settings (output off).

Output 3 is set to track output 2, and outputs 2 and 3 have Multi-On/Multi-Off not set to defaults.

Output 3 current meter has averaging turned on.

1. CC 	2. CV  TRK >	3. SET  REM 
5.000V 1.3000A	12.00V 3.000A	12.00V 1.220A*
Range:16V/6A	Range:35V/3A	Range:70V/1.5A
Vset Iset	Vset Iset	Iset



# 10 Menu - Advanced Functions

## Menu

Pressing the key marked Menu selects the System Menu screen. This provides access to advanced options and functions. When the system menu is displayed, setting of output parameters is not possible but operation of the output On/Off keys is unaffected.

Each item of the system menu is selected by using the two arrow keys, or by turning the spin wheel until the desired line is highlighted, and then pressing the Select soft key. This selects a menu screen relating to the function selected.



### Help Text

Alternatively, pressing the Help soft key provides some on-screen explanation of the highlighted function.

## 10.1 Setting Voltage Tracking

### Menu > Voltage Tracking Setup

By default all three outputs are completely independent. However, it is possible to make the voltage of an output always equal to the voltage set on another output. This is called voltage tracking.

Tracking voltages can be useful in setting up adjustable voltages of equal or opposite polarity, or when outputs are wired in parallel or in series.

Three alternative voltage tracking arrangements are possible:

- Mode 1      Output 2 tracks Output 1.
- Mode 2      Output 2 and Output 3 both track Output 1.
- Mode 3      Output 3 tracks Output 2.

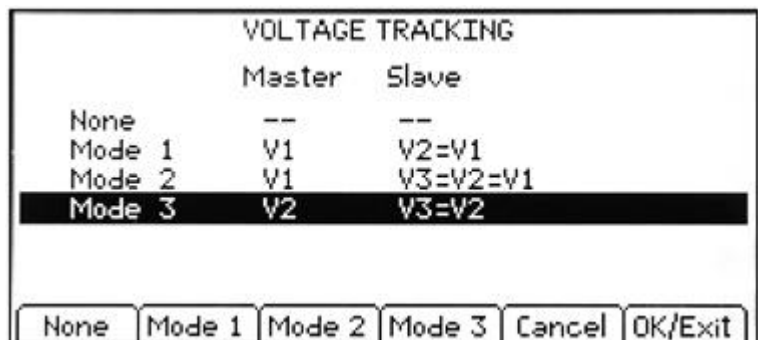

The controlling output is described as Master, whilst a controlled output is described as Slave. Voltage tracking can only be selected when the voltage range for the Slave output is equal to or higher than that of the Master output.

The tracking condition is displayed on the top line of the display, see section 9.

When tracking is set, changing the range of either the Master or Slave output will cancel tracking regardless of the direction of the change.

## 10.2 Current Meter Averaging Setup

### Menu > Current Meter Averaging Setup

The degree of averaging of the current meter reading when lavg is turned on (see section 8.4) can be set individually for each output.

The System Menu function “Current Meter Averaging Setup” provides an individual choice of low, medium or high (Low, Medium, High) for each of the three outputs set via the soft keys. The default value is medium.

## 10.3 Store and Recall of Settings for All Outputs

### Menu > Stores: All Outputs (Store/Recall)

Each output has its own set of 50 memories in which settings can be stored for that output (see section 8.7). A further set of 50 memories is provided that allow the user to store and recall the settings status for all three outputs simultaneously.

Unlike the individual memories, which store only Range, Volts, Amps, and OVP/OCP, these memories also store

the output ON/OFF state, current meter averaging state, and the Multi-On/Multi-Off settings.

Range	Volts	Amps	OVP	OCP	Output
00.1 16V/6A	6.000	2.5430	OFF	7.00	OFF (⌚)
2 35V/3A	15.00	3.000	40.0	7.00	OFF
3 70V/1.5A	65.20	1.500	80.0	3.50	OFF (⌚)
01.1 16V/6A	5.000	1.3000	OFF	7.00	OFF (⌚)
2 35V/3A	12.00	3.000	40.0	7.00	OFF
3 70V/1.5A	56.00	1.220	80.0	3.50	OFF (⌚)
Store	Recall	↑	↓	Delete	Exit

The System Menu function “Stores: All Outputs (Store/Recall)” creates a screen similar to the Stores screen for the individual outputs, but with an extra column for ON/OFF. The three outputs are listed on successive rows.

The output On/Off state is included in order to allow memories to be recalled in sequence including the turning of outputs on or off. Note that recalling a memory will override the existing On/Off state and this should be considered when setting up the power supply prior to storing each status entry.

Current meter averaging being set on is indicated by the \* symbol after the set current value. Multi-On/Multi-Off settings other than both set to Quick are indicated by a clock symbol (⌚) after the On/Off state.

Note that output delay settings are only applied when the Multi-On/Multi-Off function is used and not when a memory is recalled.

## 10.4 Multi-On / Multi-Off Operation and Sequencing

### Menu > Multi-On/Multi-Off Setup

The two keys on the bottom right hand side marked Multi-On and Multi-Off control the On and Off behaviour for all three outputs.

By default these keys provide a synchronous On/Off capability whereby all three outputs are turned on or turned off simultaneously by pressing a single key.



The System Menu function “Multi-On/Multi-Off Setup” enables the operation of these keys to be changed to suit the user’s requirements. Delays between the switching of the outputs can be introduced to create an On or Off sequence, and any individual output can be excluded from Multi-On or Multi-Off control.

At ex-factory defaults, the On and Off delays are all set to Quick causing them to respond immediately to the key press. The Tab arrow keys move through the On and Off states for the outputs which can be changed using the soft keys.

SET PROGRAMMED MULTI ON/OFF		
	Multi ON Action	Multi OFF Action
Output 1	ON after 1000ms	Quick
Output 2	Never	Quick
Output 3	ON after 660ms	Quick

Tab ← Tab → Quick Never Delay OK/Exit

- Delay sets a time value in milliseconds between 10ms and 20,000ms (20 seconds) using the spin wheel.
- Never removes an output completely from control by the Multi-On or Multi-Off key.
- Quick returns to immediate response.

Note that any previously set delay value is retained when set to Quick or Never and is restored when Delay is selected again.

When any of the settings is other than Quick, a clock symbol  is displayed on the top line of the main (Home) display, and of the individual output screen(s) to which it applies.

Note that the set delays apply only to the initiation of an output being turned on or turned off. The actual delay will depend upon the slew-rate limited turn-on or turn-off times applying to a particular output and its load. See section 12.6 for more information.

For short delay sequences, the key will flash briefly when pressed. For longer delays it will continue to flash until the sequence is completed. Where the longest delay is below approximately 250ms, the key may not flash at all.

### 10.4.1 Emergency Off

When an Off sequence that includes long delays is in progress, a second press of the Multi-Off key will turn all three outputs off immediately, including any outputs omitted from the sequence (i.e. set to Never). Thus a double press (or press and hold) of the Multi-Off key will immediately turn off all the outputs regardless of the sequence settings.

The individual output On/Off keys also remain active during a sequence and can be used to override a delay.

## 10.5 Pass Code Locking of the Front Panel

### Menu > Lock Keypad using Pass Code

In addition to the normal locking of the front panel (see section 8.10) it is also possible to lock the front panel securely by setting a pass code. This might be appropriate when the power supply is installed within a system where, once set up, changes must only be made by the installer.

The pass code is a “once only” code. After the system has been unlocked, the pass code is discarded and a new code (or the same one) must be entered in order to lock it again.

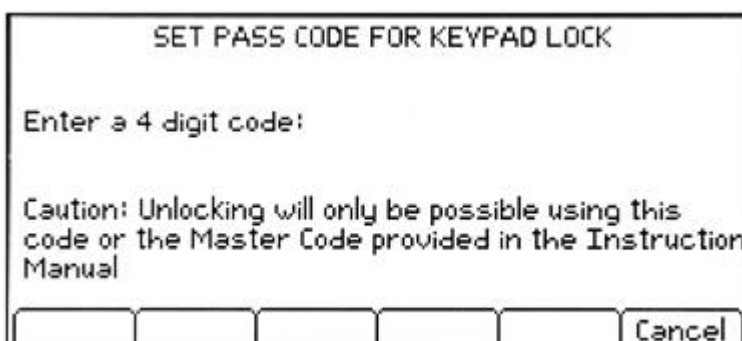

In the event that the user forgets the pass code, the power supply can be unlocked using the master pass code of 7835 which is always active.

## 10.6 System Preferences

### Menu > System Preferences

Various aspects of the power supply operation can be changed from the System Preferences function. These are detailed in section 11.

## 10.7 Setting to Factory Defaults

### Menu > Factory Defaults

This function can be used to return most of the instrument settings including Voltage, Current, Range, OVP, OCP, Output On/Off, Current Meter Averaging, Multi-On/Off Action and System Preferences back to the factory default values as listed in section 17.

The Store memories for both individual outputs and All Outputs are unaffected. To clear each bank of Stores it is necessary to use the function Stores > Delete > Del All.

LCD contrast setting and remote interface settings (MX100TP only) are also unaffected.

## 10.8 Adjusting LCD Contrast

### Menu > Adjust LCD Contrast

The LCD contrast can be adjusted over a wide range. The setting is displayed numerically as a percentage. The display can also be inverted from black on white to white on black.

## 10.9 Calibration

### Menu > Calibration

The Calibration function enables the instrument to be re-calibrated when required.



Calibration will overwrite the existing settings and should only be carried out by qualified personnel in conjunction with the instrument Service Guide and the necessary precision equipment.

A 4-digit pass code can be set to prevent unauthorised calibration if required.

## 10.10 Remote Control Interfaces (MX100TP only)

### Menu > Remote Control Interfaces

Settings for the GPIB (optional) and LAN interfaces can be observed using this function.

Details for the optional GPIB interface are within the Remote Interfaces Configuration section 13.2.1.

Details for the LAN interface are within the Remote Interfaces Configuration section 13.2.4.

# 11 Changing System Preferences

## Menu > System Preferences

Access to System Preferences is selected from the main system menu. A listing of system preferences is shown.

The current system preferences are indicated by ticks against the relevant setting. Changes are made by moving the highlight with either the arrow keys or the spin wheel and pressing the Select soft key.

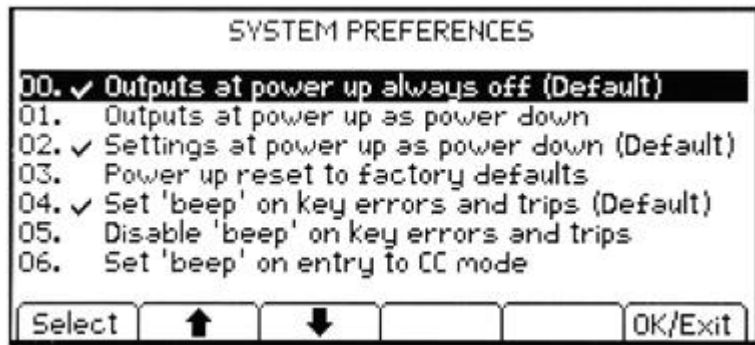

Alternatively a line can be selected directly by entering the two digit number from the keypad.

## 11.1 Status at Power-up

Outputs at power up / Settings at power up

At power-up the default behaviour is for all the outputs to be set to Off. However, the user can change this default setting such that the outputs are restored to their condition when the instrument was powered down.

The default behaviour also returns the settings (set volts, set current, range etc.) to those that existed at power-down. This can be changed so that the settings are always at factory defaults (see section 17). This includes all outputs being set to Off.

## 11.2 Alert Sound (Beep)

Set beep / Disable beep

An alert sounder is incorporated that produces a "beep" under specific conditions.

By default a beep will be sounded when an illegal key entry is made, or when a trip condition occurs. This can be disabled if preferred.

It is also possible for a beep to be sounded whenever an output changes into constant current (CC) mode. This is disabled by default.

## 11.3 Spin Wheel Action

Spin wheel action

The action of the spin wheel can be changed to reduce the speed-related increment rate. Three choices are available: normal (default), reduced acceleration, or single digit increment).

## 12 Notes on Operation

### 12.1 Accuracy and Resolution

All three outputs provide good accuracy and resolution and offer remote sensing to ensure precise regulation at the load. See section 16 for accuracy specifications.

Output 1 offers greater resolution and accuracy than outputs 2 and 3 and uses 5 digit meters to give 1mV and 0.1mA resolution (as against 10mV and 1mA for outputs 2 and 3). Consequently output 1 should be chosen to power circuits where particularly high precision is required.

### 12.2 Remote Sense

Each output has a very low output impedance, but this is inevitably increased by the resistance of the connecting leads and the contact resistance between terminals and leads. At high currents this can result in significant differences between the indicated source voltage and the actual load voltage (two 20 milliohm connecting leads will drop 0.2V at 5 Amps, for example).

This problem can be minimised by using short, thick, connecting leads, but where necessary it can be completely overcome by using the remote sense capability.

This requires the sense terminals to be connected to the output at the load instead of at the source by inserting wires into the SENSE terminals and connecting them directly to the load. The switch should then be set to REMOTE instead of LOCAL.

To avoid instability and transient response problems, care must be taken to ensure good coupling between each output and sense lead; this can best be done by twisting the leads together. An electrolytic capacitor directly across the load connection point may also be beneficial.

The voltage drop in each output lead should not exceed 0.5 Volts. Higher voltage drops could result in small metering errors or an inability to supply full power to the load when approaching maximum voltage and current.

### 12.3 Parallel Wiring of Outputs

If currents above 6 amps are required, this can be achieved by wiring two or more outputs in parallel. For example, outputs 1 and 2 could be paralleled to provide 16V/12A. In this situation it would be appropriate to use voltage tracking (Mode1  $V_2=V_1$  in this example) so that the voltage can be adjusted directly on one output. See section 10.1.

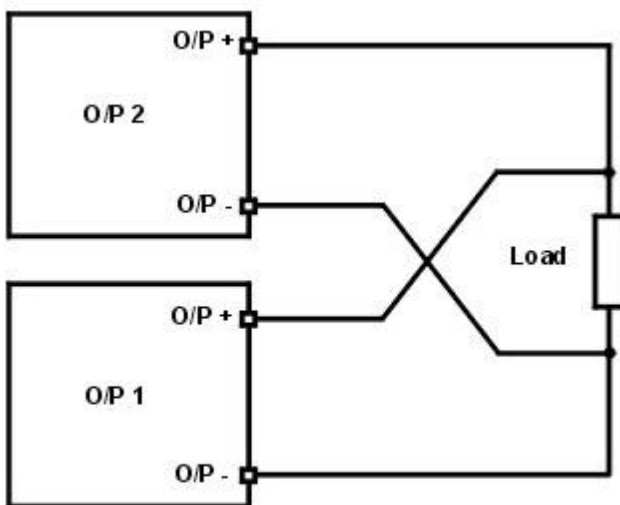

Parallel Wiring (Local Sense)

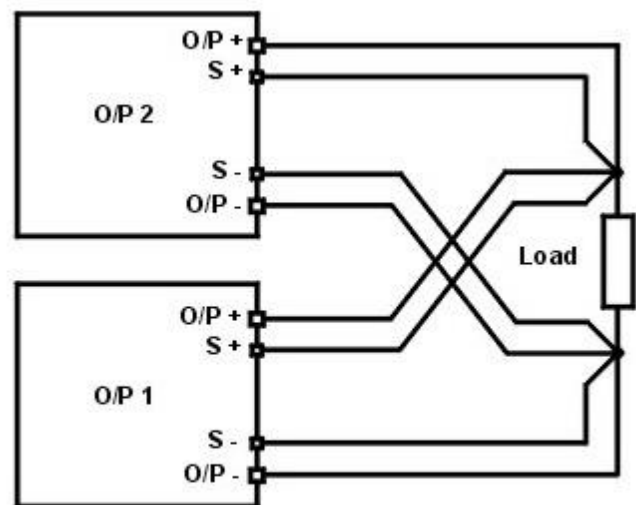

Parallel Wiring (Remote Sense)

The drawing shows a parallel connection of two outputs using local or remote sensing.

## 12.4 Series Wiring of Outputs

If voltages above 70 volts are required, this can be achieved by wiring two or more outputs in series. For example, outputs 1, 2 and 3 could be series connected to provide up to 140V.

Voltages up to 115V could be achieved by connecting all three outputs in series and selecting voltage tracking so that full voltage adjustments can be made using one output control.

The drawing shows a series connection of two outputs using local or remote sensing.

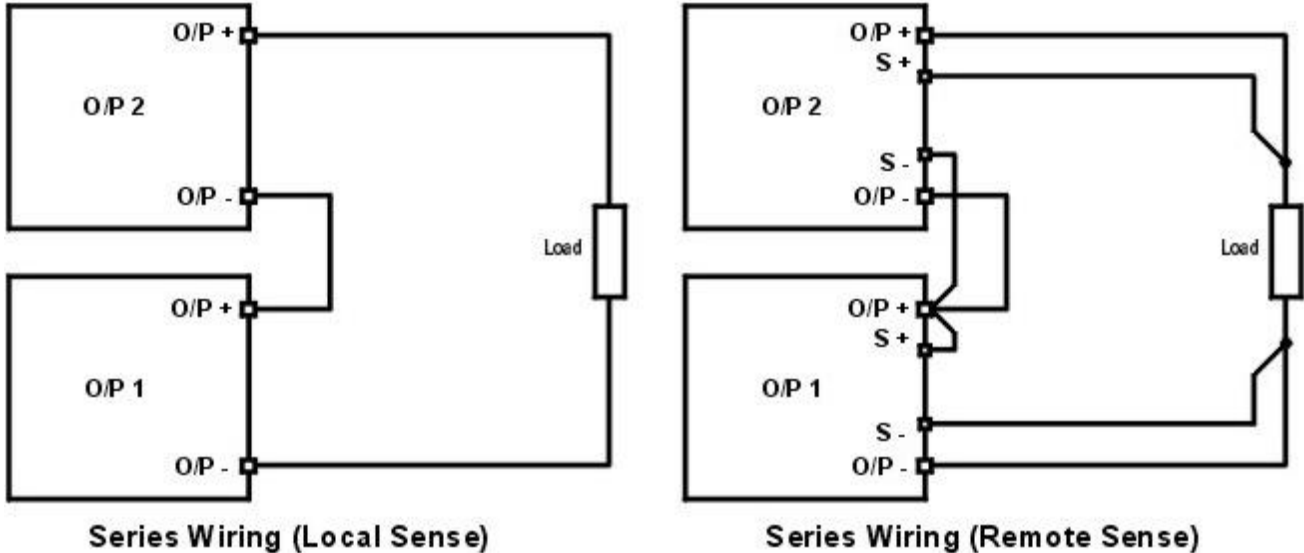

**Warning!** Voltages above 70Vdc are hazardous live according to EN 61010-1 and great care must be taken when using the power supply at voltages above this level. Ensure that the exposed end of any wires are fully inserted and inaccessible to the touch. Always make connections to the power supply with the outputs off. See also the information regarding terminal voltages and safety within section 5.3.

## 12.5 Instantaneous Current Output

The current setting control can be set to limit the continuous output current to levels down to the milliamps. However, in common with all precision bench power supplies, a capacitor is connected across the output to maintain stability and good transient response.

This capacitor charges to the output voltage and short-circuiting of the output will produce a current pulse as the capacitor discharges which is independent of the current limit setting.

## 12.6 Output On/Off and Response Speed

The output On/Off control of the power supply is entirely electronic. The Off condition is achieved by setting the voltage to zero and the current level to low. There is no physical disconnection of the outputs.

When an output is turned on or off there is a delay between the key being pressed and the output voltage or current going to zero (off) or rising to the set voltage or current (on).

The delay is a function of the loop response time of the power supply and of the stability capacitor which is placed across the output terminals. This capacitance has to be charged or discharged before the output can reach the set voltage or return to zero respectively.

Because bench power supplies are used primarily in CV (constant voltage) mode, the following explanation applies to CV mode. The situation for CC mode is different.

When switching on, the output will normally rise to the set value within a fixed length of time, typically a few milliseconds (see section 16 – Specifications). However this time could be

increased if the current setting is very low or is very close to the current required by the load. A large external capacitance at the load could also slow down the response.

When switching off with no load, the output will normally fall back to zero within a fixed length of time (see section 16 – Specifications). If a load is connected the response may be quicker because of the additional discharge provided by the load. However, if the load includes a large capacitance the response may be slower.

Turn-on and turn-off speeds are particularly relevant to Multi-On/Multi-Off output sequencing (see section 10.4) where delays between the switching of different outputs can be set to a resolution of 10ms. These delays apply only to the initiation of an output being turned on or turned off, the actual delay will depend upon the actual turn-on or turn-off times applying as described above.

In situations where the user needs to know the actual response speeds for specific conditions it will be necessary to observe this using an oscilloscope.

## 12.7 Using OVP and OCP

OVP (over-voltage protection) monitors the voltage on the output terminals and switches the output off if it exceeds the OVP setting. The response speed is typically 100us. Control of OVP is described in section 8.5.

OVP might be used to guard against accidental mis-setting of the power supply, or might be used to identify a fault condition when operating in constant current mode. Unlike the voltage limit setting, exceeding the OVP will turn the output off in a situation where damage to the device under test might otherwise occur.

OCP (over-current protection) monitors the current flowing at the output and switches the output off if it exceeds the OCP setting. The response speed is <0.5s. Control of OCP is described in section 8.5.

OCP might be used to guard against accidental mis-setting of the power supply, or might be used to identify a fault condition when operating in constant voltage mode. Unlike the current limit setting, exceeding the OCP will turn the output off in a situation where damage to the device under test might otherwise occur.

### 12.7.1 OCP Trip at Output On

If the OCP level is set to a very low level whilst also being below the set current level, it is possible for a trip condition to be created when the output is switched on. This is caused by the current needed to charge the output capacitance. Whether a trip occurs is a function of the OCP trip response speed, the OCP level, the set current and the set output voltage.

## 12.8 Over-temperature Trip (OTP)

The power supply has a sensor that monitors the internal ambient temperature. Should that exceed a safe level, as might occur if the ventilation input or output was blocked, an over-temperature protection trip (OTP) will occur. Should OTP occur, all three outputs will be turned off and an OTP message will appear on the screen.

Normal operation can only be restored by turning the AC supply (Power) off, rectifying the ventilation problem and allowing the unit to cool before switching back on.

In addition, there is a temperature sensor on the power device of the PFC (power factor correction) stage. If this detects an over-temperature problem, all power outputs will shut down; the auxiliary supply for the CPU and display will, however, remain active, and the 'Hardware Failure or Over-temperature' message screen will be displayed. If poor ventilation is suspected, correct the problem, allow the instrument to cool, and use the Reset soft-key to re-initialise the instrument. However, if the 'Hardware Failure or Over-temperature' message screen continues to be displayed after the instrument has cooled and been restarted, there may be a component fault; if in doubt, the unit should be returned for service.



## 13 Remote Interface Operation (MX100TP only)

### 13.1 MX100TP Rear Panel Connections

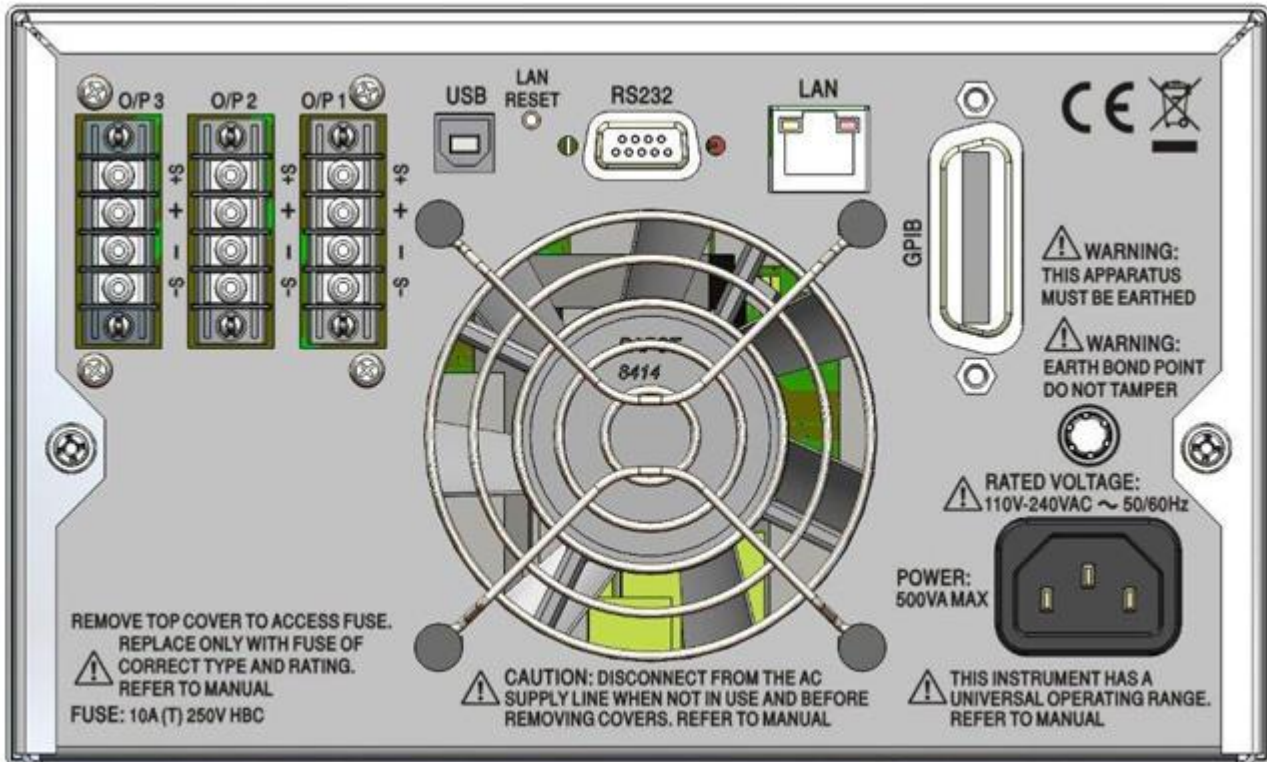

#### Output Connections

The Output and Sense terminals are duplicated on the rear panel terminal block marked Output +, Output -, Sense + and Sense -. These connections are paralleled with their front panel equivalents.

Switch the front panel LOCAL/REMOTE switch to REMOTE when remote sensing is required. When the rear panel output terminals are used, the use of remote sense is always recommended to ensure that output regulation is maintained within specification; connections can be made to either the front or the rear remote sense terminals but never to both pairs of terminals at the same time. Switch back to LOCAL when remote sensing is not in use.

#### Interface Connections

Interface connectors for USB, RS-232, LAN and GPIB (optional) are mounted on the rear panel. These are described in detail within the following sections.

### 13.2 Remote Interface Configuration

The MX100TP model can be remotely controlled via its RS232, USB, GPIB (optional) or LAN interfaces.

The optional GPIB interface provides full facilities as described in IEEE Std. 488 parts 1 and 2.

The RS232 interface communicates directly with a standard COM port.

The USB interface enumerates as a Communications Class device and interacts with application software through a standard virtual COM port device driver on the PC. The instrument firmware can be updated in the field via the USB port; see Maintenance, section 15.4 .

The LAN interface is designed to meet LXI (Lan eXtensions for Instrumentation) version 1.4 LXI Core 2011. Remote control using the LAN interface is possible using the TCP/IP Sockets protocol. The instrument also contains a basic Web server which provides information on the unit and allows it to be configured from a web browser. Simple command line control from the browser is also possible.

### 13.2.1 GPIB Interface (optional)

The standard optional GPIB interface 24-way connector is located on the instrument rear panel. The pin connections are as specified in IEEE Std. 488.1-1987 and the instrument complies with both IEEE Std. 488.1-1987 and IEEE Std. 488.2-1987.

It provides full talker, listener, service request, serial poll and parallel poll capabilities. There are no device trigger or controller capabilities. The IEEE Std.488.1 interface subsets provided are:

SH1, AH1, T6, L4, SR1, RL2, PP1, DC1, DT0, C0, E2.

The optional GPIB address of the unit is set from the system menu:

Settings can be changed from the System Menu (Menu > Remote Control Interfaces). The present GPIB address (optional) is displayed. To change the address, use the spin-wheel to set the desired address and then press the OK/Exit soft key.

The interface will operate with any commercial GPIB interface card (optional), using the device drivers and support software provided by the manufacturer of that card.

### 13.2.2 RS232 Interface

The 9-way D-type serial interface connector is located on the instrument rear panel. It should be connected to a standard PC port preferably using a fully wired 9 way 1:1 male-female cable without any cross-over connections. Alternatively, a 3-way cable can be used, connecting only pins 2, 3 and 5 to the PC, but with links made in the connector at the PC end between pins 1, 4 and 6 and between pins 7 and 8, as shown in the diagram:

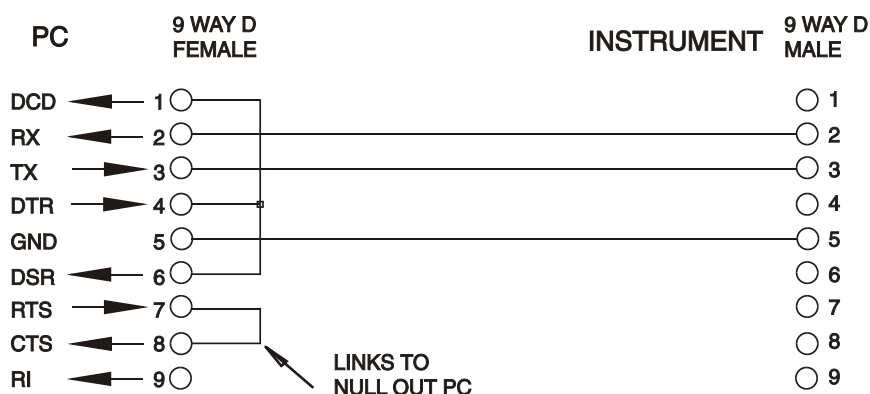

Most commercial cables provide these connections.

In addition to the transmit and receive data lines, the instrument passively asserts pins 1 (DCD) and 6 (DSR), actively drives pin 8 (CTS) and monitors pin 4 (DTR) from the PC. This allows the use of a fully wired 9-way cable.

The Baud Rate for this instrument is fixed at 9600; the other parameters are 8 data bits, no parity and one stop bit. Flow control uses the XON/XOFF protocol, but because of the low volume of data associated with this instrument it is very unlikely that flow control will actually be invoked.

### 13.2.3 USB Interface and Device Driver Installation

The instrument firmware can be updated in the field through the USB port. This does not need the driver described here. It requires a PC software utility provided by the manufacturer, and uses a HID driver that will already be installed on the PC. If that is the only USB functionality required, download the package containing the firmware update together with the PC utility from the manufacturer, and follow the instructions included.

Using the USB interface for remote control requires a Communications Device Class driver on the PC to provide a virtual COM port instance. In Windows a suitable driver is provided by Microsoft, but it is not installed by default. The data (.INF) file to control the installation is provided on the Product Documentation CD delivered with the unit; however the same driver is also used by many other instruments from this manufacturer and may already be known to the PC.

To install the driver for the first time, first switch the unit on, and then connect the USB port to the PC. The Windows plug and play functions should automatically recognise the attachment of new hardware to the USB interface and (possibly after searching the internet for some time) prompt for the location of a suitable driver. Follow the Windows prompts and point to the CD, then the sub-directory for this product, and then to the USB Driver sub-directory below that. The file is named USB\_ARM\_VCP\_xxx.INF, where xxx is a version number. (A readme.pdf file will also be found in that directory if further assistance is needed.)

In some cases Windows will not complete this procedure (especially recent versions which search the internet first, looking for the unique Vendor ID and Product ID), in which case the instrument will show in Device Manager as “not working properly”. If this happens, select this device, right click and choose “update driver software...” and then “browse this computer for driver software...” and then locate the .INF file on the CD as described above.

Once Windows has installed the device driver it will assign a COM port number to this particular unit. This number will depend on previous COM port assignments on this PC, and it may be necessary to use Device Manager to discover it. Each instrument has a unique USB identifier which is remembered by the system, so it will receive the same COM port number whenever it is attached to the same PC (regardless of the physical interface socket used), even though the COM port will disappear while the instrument is disconnected or switched off. Other instruments will receive different COM port numbers.

Note that a different PC will not necessarily assign the same COM port number to a particular instrument (it depends on the history of installations), however Device Manager can be used to change the assignments given.

This virtual COM port can be driven by Windows applications (including a terminal emulator) in exactly the same way as any standard COM port, except that the Baud rate and other settings are unnecessary and are ignored. Some old applications might not function with COM port numbers 3 or 4, or above 9. In this case, use Device Manager to change the allocation given. Once it is installed, the driver will be maintained by Windows Update in the usual way.





### 13.2.4 LAN Interface

The LAN interface is designed to comply with the LXI standard version 1.4 LXI Core 2011 and contains the interfaces and protocols described below. For more information on LXI standards refer to [www.lxistandard.org](http://www.lxistandard.org).

When powered up and attached to a network, the unit will by default attempt to obtain IP address and netmask settings via DHCP, or, if DHCP times out (after 30 seconds), via Auto-IP. In the very unlikely event that an Auto-IP address cannot be found a static IP address is assigned; the default is 192.168.0.100, but this can be changed on the web page. Connecting via a router is recommended as this is significantly quicker to assign an IP address; connecting directly to a PC will only begin to assign an Auto-IP address after the 30 second DHCP timeout.

Since it is possible to misconfigure the LAN interface, making it impossible to communicate with the instrument over LAN, a LAN Configuration Initialise (LCI) mechanism is provided via a push switch (marked LAN RESET) accessible through a small hole in the rear panel. This restores the default configuration with DHCP enabled, so the unit will then follow the sequence described in the previous paragraph. Note that resetting the LAN interface removes any password protection.

The progress of establishing a LAN connection can be viewed either by inspecting the Remote Control Interfaces screen (Menu > Remote Control Interfaces) or by interpreting the symbol shown on the status line of the Home screen, which has four possible indications:

No LAN	If the unit cannot detect any connection to a LAN, e.g. the cable is unplugged, then the LAN status indicator is  .
Configuring	The unit has detected a LAN connection but is not yet configured, e.g. is waiting for DHCP. The LAN status indicator is animated, flashing between  and  .
LAN OK	The LAN connection is now configured and the unit can communicate. The display becomes  .
LAN FAULT	The unit has detected a problem with LAN connection, e.g. Its IP address is in use by another device. Communication is not possible and the display shows  .

### 13.2.5 LAN IP Address and Hostname

To communicate with the instrument through the LAN interface, the IP address (which was allocated during the connection procedure described above) must be known. Once connected and correctly configured, the IP address of the unit is displayed within the Remote Control Interfaces screen (Menu > Remote Control Interfaces). Alternatively the address can be obtained from the DHCP server, or by using the LXI Discovery Tool described below.

#### mDNS and DNS-SD Support

The instrument supports these multicast name resolution protocols, which allow a meaningful host name to be assigned to the unit without needing an entry in the database of a central nameserver. The desired hostname can be entered on the webpage (which will have to be accessed by IP address the first time); spaces are not allowed. The name then appears in the .local domain (e.g. myMX100.local), if the accessing device is configured to support the protocol (which is the case with most modern PCs). The default name is followed by the serial number.

#### ICMP Ping Server

The unit contains an ICMP server allowing the instrument to be 'pinged' using its IP address as a basic communication check, or by its host name if name resolution is working.

#### Web Server and Configuration Password Protection

The unit contains a basic web server. This provides information on the instrument and allows it to be configured. The Configure and Instrument Control pages can be password protected to deter unauthorised changes to the remote operation configuration; the default configuration is 'no password'. The Configure page itself explains how to set the password. The password can be up to 15 characters long; note that the User Name should be left blank. The password and hostname will, however, be reset to the default (no password) if the rear panel LAN reset switch is used to reset all the LAN parameters to their factory default.

#### LAN Identify

The instrument's main web page has an 'Identify' function which allows the user to send a command to the instrument which causes its display to flash until the command is cancelled.

## **LXI Discovery Tool**

This tool can be used to display the IP addresses and other associated information of all connected devices that comply with the VXI-11 discovery protocol. It is a Windows PC application, which is provided on the supplied CD ROM that can be installed and run on the controlling PC, with the unit either connected directly to the PC network connector or via a router. Double clicking on any entry in the list of discovered devices will open the PC's web browser and display the Home page of that device. For a later version of the tool that supports discovery by both VXI-11 and mDNS visit [www.lxistandard.org](http://www.lxistandard.org) . There are also tools for LAN discovery included as part of the National Instruments Measurement and Automation Explorer package and the Agilent Vee application.

### **VXI-11 Discovery Protocol**

The instrument has very limited support of VXI-11 which is sufficient for the discovery protocol and no more.

It implements a Sun RPC Port-mapper on TCP port 111 and UDP port 111 as defined in RFC1183. The calls supported are:

NULL, GET PORT and DUMP.

On TCP port 1024 a very simple VXI-11 protocol is implemented, sufficient only for instrument discovery. This implements the following calls:

CREATE LINK, DEVICE\_WRITE, DEVICE\_READ and DESTROY\_LINK.

Once a link has been created anything written to the device is ignored and any attempt to read from the device returns the same identification string as the \*IDN? query.

### **VISA Resource Name**

Because of the limited support for VXI-11 (Discovery Protocol only), the instrument must be referred to by its raw socket information when used with software packages which communicate using a VISA resource name. For example, an instrument at IP address 192.168.0.100 would normally have a VISA resource name of "TCPIP0::192.168.0.100::inst0::INSTR" but for this instrument the name must be modified to read "TCPIP0::192.168.0.100::9221::SOCKET" where 9221 is the TCP port used by this instrument for control and monitoring, see below.

### **XML Identification Document URL**

As required by the LXI standard, the instrument provides an XML identification document that can be queried via a GET at "http://IPaddress:80/lxi/identification" that conforms to the LXI XSD Schema (available at <http://www.lxistandard.org/InstrumentIdentification/1.0> ) and the W3C XML Schema Standards ( <http://www.w3.org/XML/Schema> ). This document describes the instrument. The hostname can be used instead of the IP address if name resolution is working.

### **TCP Sockets**

The instrument uses 2 sockets on TCP port 9221 for instrument control and monitoring. Text commands are sent to this port as defined in 'Remote Commands' and any replies are returned via the same port. Any command string must contain one or more complete commands. Multiple commands may be separated with either semicolons ";" or line feeds. No final terminator is required, since the TCP frame implies a terminator, but one may be sent if desired.

## **13.2.6 Interface Locking**

All the remote interfaces are live at all times, to remove any need to select the active interface and to ensure that the LAN interface is always available (as demanded by the LXI standard). To reduce the risk of the instrument being inadvertently under the control of two interfaces at once a simple lock and release mechanism is provided in the instruction set. The lock is automatically released where it is possible to detect disconnection, or when the Local key is pressed. Access to the interfaces may also be restricted using the web pages.

Any interface may request to have exclusive control of the instrument by sending an "IFLOCK 1" command. The lock may only be released by sending an "IFLOCK 0" command from the

interface instance that currently has the lock, and may be queried from any interface by sending an "IFLOCK?" command. The reply to this query will be "-1" if the lock is owned by another interface instance, "0" if the interface is free and "1" if the lock is owned by the requesting interface instance. Sending any command from an interface without control privileges that attempts to change the instrument status will set bit 4 of the Standard Event Status Register and put 200 into the Execution Error Register to indicate that there are not sufficient privileges for the required action.

**Note:** it is also possible to configure the privileges for a particular interface to either 'read only' or 'no access' from the Web page interface.

### 13.2.7 Status Reporting

The standard status and error reporting model described in IEEE Std. 488.2 was designed for the optional GPIB interface and contains some features intended for use with the Service Request and Parallel Poll hardware capabilities of that interface, and to accommodate its semi-duplex operation. Although those facilities are of little use with other interfaces, this instrument makes the full set of capabilities available to all of the interfaces. A separate set of many of the status and error registers is maintained for each potential interface instance. The GPIB (optional), USB and RS232 interfaces each provide a single instance, while the LAN interface provides three: one for the Web page and one each for the two TCP socket interfaces. Having a separate status model for each interface instance ensures that data does not get lost, as some status query commands (e.g. "\*ESR?") clear the contents of a register after reading the present value.

The full set of error and status registers and the individual bits they contain is shown in the Status Model Diagram and described in detail below, but in brief the status is maintained using five primary registers, the Limit Event Status Register for each output, the Standard Event Status Register and the Execution Error Register. A summary is reported in the Status Byte Register, as selected by four masking registers, the Limit Status Enable Register for each output and the Standard Event Status Enable Register. Two further mask registers, the Service Request Enable register and the Parallel Poll Response Enable register, control operation of the GPIB hardware (optional) Service Request and Parallel Poll (and the associated **ist** message) respectively. It is recommended that, when controlling the unit through any interface other than the optional GPIB, the controller program should simply read the primary status registers directly.

The Standard Event Status Register, supported by the Execution Error and Query Error registers, records events concerned with command parsing and execution, and the flow of commands, queries, and responses across the interface. These are mainly of use during software development, as a production test procedure should never generate any of these errors.

#### Limit Event Status and Limit Event Status Enable Registers

This pair of registers are implemented for each output as an addition to the IEEE Std.488.2. Their purpose is to inform the controller of entry to and/or exit from current or voltage limit conditions and the history of protection trip conditions since the last read.

Any bits set in the Limit Event Status Register (LSR<N>) which correspond to bits set in the Limit Event Status Enable Register (LSE<N>) will cause the LIM<N> bit to be set in the Status Byte Register, where <N> is 1 for output 1, 2 for output 2 and 3 for output 3.

The Limit Event Status Register is read and cleared by the LSR<N>? command. The Limit Event Status Enable Register is set by the LSE<N> <NRF> command and read by the LSE<N>? command.

- Bit 7 - Reserved for future use
- Bit 6 - Set when a fault trip has occurred which requires AC power OFF/ON to reset.
- Bit 5 - Reserved for future use
- Bit 4 - Reserved for future use
- Bit 3 - Set when an output over current trip has occurred
- Bit 2 - Set when an output over voltage trip has occurred
- Bit 1 - Set when output enters current limit (constant current mode)
- Bit 0 - Set when output enters voltage limit (constant voltage mode)

### Standard Event Status Registers (ESR and ESE)

The Standard Event Status Register is defined by the IEEE Std. 488.2 GPIB standard. It is a bit field, where each bit is independent and has the following significance:

- Bit 7 **Power On.** Set when power is first applied to the instrument.
- Bits 6 & 1: *Not used, permanently 0.*
- Bit 5 **Command Error.** Set when a syntax error is detected in a command or parameter. The parser is reset and parsing continues at the next byte in the input stream.
- Bit 4 **Execution Error.** Set when a non-zero value is written to the Execution Error register, if a syntactically correct command cannot be executed for any reason.
- Bit 3 **Verify Timeout Error.** Set when a parameter is set with 'verify' specified and the value is not reached within 5 secs, e.g. output voltage is slowed by a large capacitor on the output.
- Bit 2 **Query Error.** Set when a query error occurs, because the controller has not issued commands and read response messages in the correct sequence.
- Bit 0 **Operation Complete.** Set in response to the '\*OPC' command.

The Standard Event Status Register is read and cleared by the \*ESR? query, which returns a decimal number corresponding to the contents. On power-up it is set to 128, to report the power on bit.

The Standard Event Status Enable Register provides a mask between the Event Status Register and the Status Byte Register. If any bit becomes '1' in both registers, then the ESB bit will be set in the Status Byte Register. This enable register is set by the \*ESE <NRF> command to a value 0 - 255, and read back by the \*ESE? query (which will always return the value last set by the controller). On power-up it is set to 0.

### Execution Error Register (EER)

This instrument specific register contains a number representing the last command processing error encountered over this interface. The error numbers have the following meaning:

- 0 No error has occurred since this register was last read.
- 100 **Numeric Error:** the parameter value sent was outside the permitted range for the command in the present circumstances.
- 102 **Recall Error:** a recall of set up data has been requested but the store specified does not contain any data.
- 103 **Command Invalid:** the command is recognised but is not valid in the current circumstances. Typical examples would be trying to change V2 directly while the outputs are in voltage tracking mode with V1 as the master.
- 200 **Access Denied:** an attempt was made to change the instrument's settings from an interface which is locked out of write privileges by a lock held by another interface.

The Execution Error Register is read and cleared using the 'EER?' command. On power up this register is set to 0 for all interface instances.

There is no corresponding mask register: if any of these errors occurs, then bit 4 of the Standard Event Status Register will be set. This bit can be masked from any further consequences by clearing bit 4 of the Standard Event Status Enable Register.

### **Status Byte Register (STB) and GPIB Service Request Enable Register (SRE) (optional)**

These two registers are implemented as required by the IEEE Std. 488.2.

Any bits set in the Status Byte Register which correspond to bits set in the Service Request Enable Register will cause the RQS/MSS bit to be set in the Status Byte Register, thus generating a Service Request on the bus.

The Status Byte Register is read either by the \*STB? query, which will return MSS in bit 6, or by a Serial Poll which will return RQS in bit 6. The Service Request Enable register is set by the \*SRE <NRF> command and read by the \*SRE? Query.

Bits 7 & 3 : *Not used, permanently 0.*

- Bit 6      **MSS/RQS.** This bit (as defined by IEEE Std. 488.2) contains alternatively the Master Status Summary message returned in response to the \*STB? query, or the Requesting Service message returned in response to a Serial Poll. The RQS message is cleared when polled, but the MSS bit remains set for as long as the condition is true.
- Bit 5      **ESB.** The **Event Status** Bit. This bit is set if any bits set in the Standard Event Status Register correspond to bits set in the Standard Event Status Enable Register.
- Bit 4      **MAV.** The **Message Available** Bit. This will be set when the instrument has a response message formatted and ready to send to the controller. The bit will be cleared after the Response Message Terminator has been sent.
- Bit 2      **LIM3.** The **Output3 Limit Status** Bit. This will be set if any bits in the Limit Event Status register for output3 are set and corresponding bits are set in the Limit Event Status Enable register LSE3.
- Bit 1      **LIM2.** The **Output2 Limit Status** Bit. This will be set if any bits in the Limit Event Status register for output2 are set and corresponding bits are set in the Limit Event Status Enable register LSE2.
- Bit 0      **LIM1.** The **Output1 Limit Status** Bit. This will be set if any bits in the Limit Event Status register for output1 are set and corresponding bits are set in the Limit Event Status Enable register LSE1.

### **GPIB Parallel Poll (PRE) (optional)**

Complete Parallel Poll capabilities are offered by this instrument as defined in IEEE Std. 488.1. The Parallel Poll Enable Register (which is set by the \*PRE <NRF> command and read by the \*PRE? query) specifies which bits in the Status Byte Register are to be used to form the **ist** local message. If any bit is '1' in both the STB and the PRE then **ist** is '1', otherwise it is '0'. The state of the **ist** message can also be read directly by the \*IST? query.

The physical layer protocol of the Parallel Poll (determining which data line is to be driven and its logic sense) is configured by the PPC and PPE commands and released by the PPU and PPD commands in the manner defined by the standard. The instrument implements passive pull-up on the DIO lines during Parallel Poll.

### **Query Error Register - GPIB IEEE Std. 488.2 Error Handling**

These errors are much more likely to occur on the semi-duplex optional GPIB interface, which requires the instrument to hold a response until addressed to talk by the controller. All the other interfaces provide full duplex communication, with buffering in the physical layer which will



usually hold a response from the instrument until the controlling software reads it; there is no equivalent of the optional GPIB state 'addressed to talk', so the instrument is not aware of the actions of the controller.

The IEEE 488.2 UNTERMINATED error arises if the instrument is addressed to talk and has nothing to say, because the response formatter is inactive and the input queue is empty. This will cause the Query Error bit to be set in the Standard Event Status Register, a value of 3 to be placed in the Query Error Register and the parser to be reset.

The IEEE 488.2 DEADLOCK error arises if the response formatter is waiting to send a response message and the input queue becomes full. This will cause the Query Error bit to be set in the Standard Event Status Register, a value of 2 to be placed in the Query Error Register and the response formatter to be reset, discarding the waiting response message. The parser will then start parsing the next <PROGRAM MESSAGE UNIT> from the input queue.

The IEEE 488.2 INTERRUPTED error arises if the response formatter is waiting to send a response message and a <PROGRAM MESSAGE TERMINATOR> has been read by the parser, or the input queue contains more than one END message. This will cause the Query Error bit to be set in the Standard Event Status Register, a value of 1 to be placed in the Query Error Register and the response formatter to be reset, discarding the waiting response message. The parser will then start parsing the next <PROGRAM MESSAGE UNIT> from the input queue.

### Power on Settings

The following instrument status values are set at power on:

EER	Execution Error Register	= 0
ESR	Standard Event Status Register	= 128 (pon bit set)
QER	Query Error Register †	= 0
ESE	Standard Event Status Enable Register †	= 0
STB	Status Byte Register	= 0
SRE	Service Request Enable Register †	= 0
PRE	Parallel Poll Response Enable Register †	= 0

† Registers marked thus are normally only used through the optional GPIB interface.

The instrument will be in local state with the keyboard active. By default, the instrument settings at power on are the same as at the last switch off and the outputs are off. These parameters may be configured by the user to allow outputs to be the same as at the last switch off or, alternatively, all settings and outputs may be reset to factory defaults at power on, see 11.1.

### Register Summary

Set	Query	Name
	LSR1?, LSR2?, LSR3?	Limit Status Registers
LSE1, LSE2, LSE3	LSE1?, LSE2?, LSE3?	Limit Status Enable Registers
†	EER?	Execution Error Register
†	QER?	Query Error Register
†	*ESR?	Standard Event Status Register
*ESE	*ESE?	Standard Event Status Enable Register
	*STB?	Status Byte Register
*SRE	*SRE?	Status Byte Enable Register
*PRE	*PRE?	Parallel Poll Response Enable Register

† These registers are cleared after being queried, or by the \*CLS command.

### Status Model

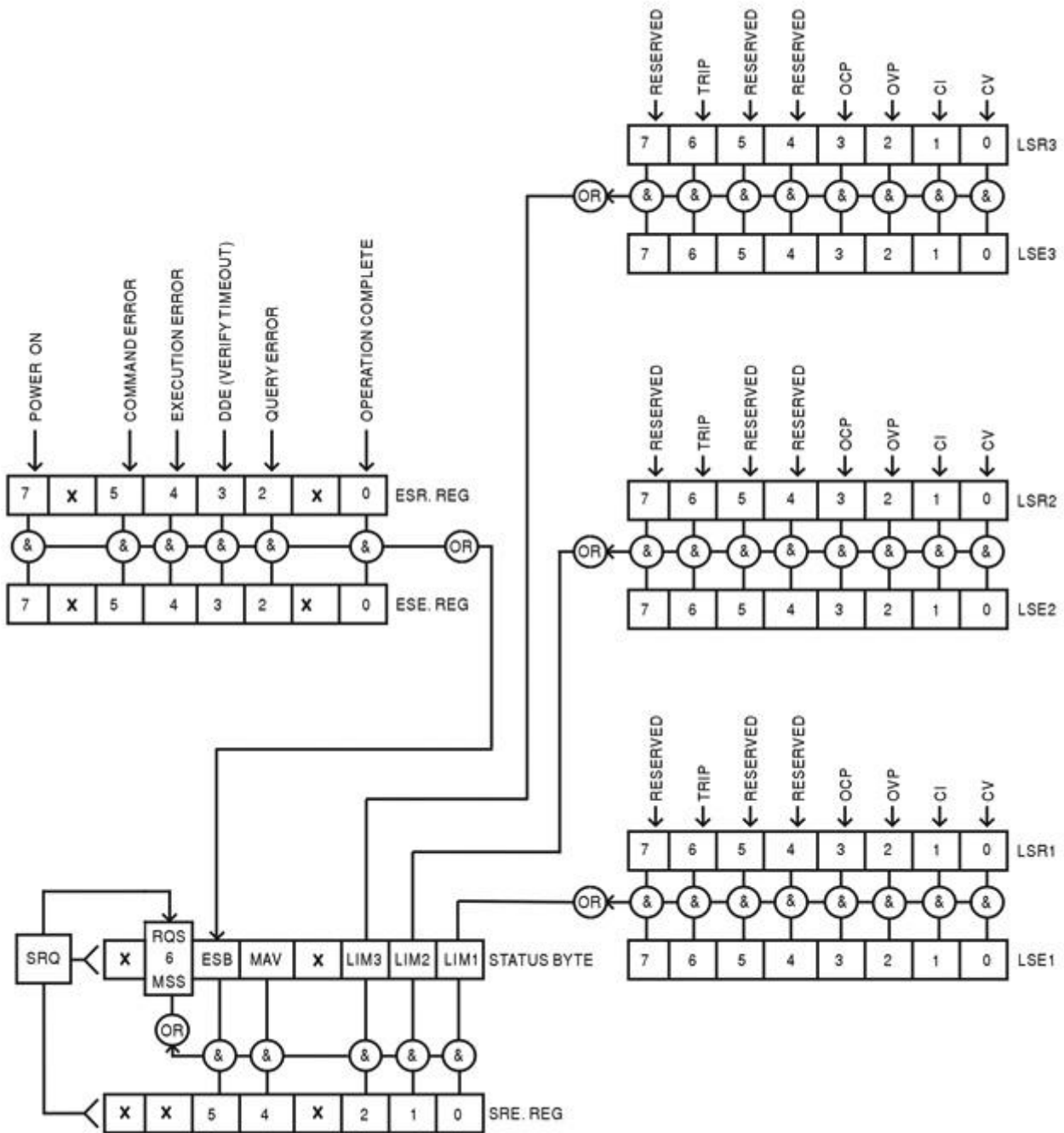

---

## 14 Remote Commands (MX100TP only)

### 14.1 General

#### 14.1.1 Remote and Local Operation

At power-on the instrument will be in the local state, with normal keyboard operation possible. All remote interfaces are active and listening for a remote command. When any command is received from any interface the instrument will enter the remote state. In this state the keyboard is locked out, the display switches to the home screen, with REM displayed in the upper right corner. The instrument may be returned to the local state by pressing the LOCAL key; however the remote state will be immediately re-entered if the instrument is addressed again or receives another command from any interface. It is the responsibility of the user to avoid any conflict if parameters are changed from the front panel while in the local state.

#### 14.1.2 Remote Command Handling

Each remote-control interface has a separate input queue which is filled, under interrupt, in a manner transparent to all other instrument operations. The RS232 interface implements flow control by sending XOFF when the queue contains approximately 200 characters, and then XON when about 100 free spaces become available. All the other interfaces have standard automatic flow control mechanisms built into their physical layer communication protocol.

Commands are taken from the input queues by the parser as available. Commands and queries from each queue are executed in order, but the order of execution of commands from different interfaces is not defined and should not be relied upon. It is strongly recommended that use should be made of the interface locking facilities described above. The parser will not start a new command until any previous command or query is complete. Responses are sent to the interface which issued the query. There is no internal output queue, so on the optional GPIB interface the response formatter will wait, indefinitely, if necessary, until the complete response message has been read by the controller before the parser is allowed to start the next command in the input queue. On all other interfaces the response message is immediately sent into buffers in the physical layer.

#### 14.1.3 Remote Command Formats

Commands are sent as <PROGRAM MESSAGES> by the controller, each consisting of zero or more <PROGRAM MESSAGE UNIT> elements, separated (if there is more than one such element) by <PROGRAM MESSAGE UNIT SEPARATOR> elements, and finally a <PROGRAM MESSAGE TERMINATOR>.

The <PROGRAM MESSAGE UNIT SEPARATOR> is the semi-colon character ';' (3BH).

The <PROGRAM MESSAGE TERMINATOR>, which separates or terminates <PROGRAM MESSAGES>, is the new line character (0AH), but in the case of the optional GPIB interface the hardware END message may also be used, either with the last character of the message or with the new line. In the case of the LAN interface, commands may not be split across TCP/IP packet boundaries.

A <PROGRAM MESSAGE UNIT> is any of the commands in the remote commands list, which must be sent in full as specified. A command must be separated from any parameters by <WHITE SPACE> (which is defined as the character codes 00H to 20H inclusive, excluding the new line character 0AH). No <WHITE SPACE> is permitted within any command identifier or parameter, but any other additional <WHITE SPACE> is ignored. Note that the Backspace character (07H) is treated as <WHITE SPACE>, so it cannot be used to delete incorrect characters, and will not hide the error.

The high bit of all characters is ignored and all commands are case insensitive. Commands that require a numeric a parameter accept the free form <NRF> format; text parameters must be sent as Character Program Data <CPD> as specified.

<NRF> numbers must be in basic units, may have a decimal point and fractional part, and can include an exponent part if helpful. They are rounded to the precision supported by the instrument.

#### 14.1.4 Command Timing

There are no dependent parameters, coupled parameters, overlapping commands, expression program data elements or compound command program headers. .

All commands are separate and sequential, and are executed when parsed and immediately considered complete. To provide useful functionality, the Operation Complete bit (bit 0) in the Standard Event Status Register is only ever set by the \*OPC command. Either the \*OPC command or the \*OPC? query can be used for device synchronisation due to the sequential nature of remote operations.

#### 14.1.5 Response Formats

Responses from the instrument to the controller are sent as <RESPONSE MESSAGES>, which consist of one <RESPONSE MESSAGE UNIT> followed by a <RESPONSE MESSAGE TERMINATOR>, which is the carriage return character (0DH) followed by the new line character (0AH) with, in the case of GPIB (optional) only, the END message NL^END. This is shown as <RMT> in the descriptions below.

Each query produces a specific <RESPONSE MESSAGE> which is described in the entry for the query command in the remote commands list below. Most responses consist of a keyword followed by either text or a number in one of the following formats:

- <NR1> An integer without a decimal point or a unit.
- <NR2> A fixed point number with a fractional part but no exponent part.
- <NR3> A floating point number with both a fractional part and an exponent part.
- <CRD> Character Response Data, consisting of the text characters listed.
- <N> The number of the output or status register to which the command relates.

### 14.2 Command List

This section lists all the commands and queries implemented in this instrument. All numeric parameters are shown as <NRF> and may be sent as <NR1>, <NR2> or <NR3> as described above. Command parameters (unlike responses) are not followed by a units indication.

#### 14.2.1 Instrument Function Commands

- V<N> <NRF> Set output <N> to <NRF> Volts.
- V<N>V <NRF> Set output <N> to <NRF> Volts with verify.
- OVP<N> <NRF> Set output <N> over voltage protection trip point to <NRF> Volts.
- OVP<N> <CPD> Enables or disables the over voltage protection trip point where <CPD> can be ON or OFF.
- I<N> <NRF> Set output <N> current limit to <NRF> Amps.
- OCP<N> <NRF> Set output <N> over current protection trip point to <NRF> Amps.
- OCP<N> <CPD> Enables or disables the over current protection trip point where <CPD> can be ON or OFF.
- DAMPING<N> <CPD> Set the current meter measurement averaging of output <N> to <CPD>, where <CPD> can be ON, OFF, LOW, MED or HIGH.
- V<N>? Return the set voltage of output <N>.  
Response is V<N> <NR2><RMT> where <NR2> is in Volts.
- I<N>? Return the set current limit of output <N>.  
Response is I<N> <NR2><RMT> where <NR2> is in Amps.

OVP<N>?	Return the voltage trip setting of output <N>. Response is VP<N> <NR2><RMT> where <NR2> is in Volts. Note: If over voltage protection has been disabled the response is VP<N> <CRD><RMT> where <CRD> is OFF.
OCP<N>?	Return the current trip setting of output<N>. Response is CP<N> <NR2><RMT> where <NR2> is in Amps. Note: If over current protection has been disabled the response is CP<N> <CRD><RMT> where <CRD> is OFF.
V<N>O?	Return the output readback voltage of output <N> Response is <NR2>V<RMT> where <NR2> is in Volts.
I<N>O?	Return the output readback current of output <N> Response is <NR2>A<RMT> where <NR2> is in Amps.
DELTA V<N> <NRF>	Set the output voltage step size of output <N> to <NRF> Volts.
DELTA I<N> <NRF>	Set the output current step size of output <N> to <NRF> Amps.
DELTA V<N>?	Return the output voltage step size of output <N> Response is DELTA V<N> <NR2><RMT>, where <NR2> is in Volts.
DELTA I<N>?	Return the output current step size of output <N> Response is DELTA I<N> <NR2><RMT>, where <NR2> is in Amps.
INCV<N>	Increment the output<N> voltage by step size.
INCV<N>V	Increment the output<N> voltage by step size, with verify.
DECV<N>	Decrement the output<N> voltage by step size.
DECV<N>V	Decrement output<N> voltage by step size, with verify.
INCI<N>	Increment the output<N> current limit by step size.
DECI<N>	Decrement the output<N> current limit by step size.
OP<N> <NRF>	Set output<N> on/off where <NRF> has the following meaning: 0=OFF, 1=ON.
OP<N>?	Returns output<N> on/off status. The response is <NR1><RMT> where 1 = ON, 0 = OFF.
OPALL <NRF>	By default simultaneously sets all outputs on/off where <NRF> has the following meaning: 0=ALL OFF, 1=ALL ON. However this behaviour can be changed to turn the outputs on or off in a timed sequence or to omit an output entirely. See section 10.4 for an explanation.
TRIPRST	Attempt to clear all trip conditions.
VRANGE<N> <NRF>	Set output<N> voltage range to <NRF> where <NRF> has the following meaning: Output1: 1= 16V/6A, 2 = 35V/3A. Output2: 1= 35V/3A, 2 = 16V/6A, 3 = 35V/6A. Output3: 1= 35V/3A, 2 = 70V/1.5A, 3 = 70V/3A.
VRANGE<N>?	Returns the voltage range for output<N>. The response is <NR1><RMT> where <NR1> has the following meaning: Output1: 1= 16V/6A, 2 = 35V/3A. Output2: 1= 35V/3A, 2 = 16V/6A, 3 = 35V/6A. Output3: 1= 35V/3A, 2 = 70V/1.5A, 3 = 70V/3A.

CONFIG <NRF>	<p>Sets the voltage tracking mode of the unit to &lt;NRF&gt; where &lt;NRF&gt; has the following meaning:</p> <p>0 = None.  1 = Mode1.  2 = Mode2.  3 = Mode3.</p> <p>These modes are as defined within the Setting Voltage Tracking section of this manual – see section 10.1.</p>
CONFIG?	<p>Returns the voltage tracking mode of the unit. The response is &lt;NR1&gt;&lt;RMT&gt;, where &lt;NR1&gt; has the following meaning:</p> <p>0 = None.  1 = Mode1.  2 = Mode2.  3 = Mode3.</p> <p>These modes are as defined within the Setting Voltage Tracking section of this manual – see section 10.1.</p>
ONDELAY<N> <NRF>	Set output<N> Multi-On delay where <NRF> is in milliseconds
OFFDELAY<N> <NRF>	Set output<N> Multi-Off delay where <NRF> is in milliseconds
ONACTION<N> <CPD>	Set output<N> Multi-On action where <CPD> can be QUICK, NEVER or DELAY.
OFFACTION<N> <CPD>	Set output<N> Multi-Off action where <CPD> can be QUICK, NEVER or DELAY.
SAV<N> <NRF>	Save the current settings of output<N> to the store specified by <NRF> where <NRF> can be 0-49.
RCL<N> <NRF>	Recall the settings for output<N> from the store specified by <NRF> where <NRF> can be 0-49.

## 14.2.2 Common Commands

*IDN?	<p>Returns the instrument identification.</p> <p>The response is in the form &lt;NAME&gt;, &lt;model&gt;, &lt;serial&gt;, &lt;version&gt;&lt;RMT&gt; where &lt;NAME&gt; is the manufacturer's name, &lt;model&gt; is the instrument type, &lt;serial&gt; is the interface serial number and &lt;version&gt; is the revision level of the firmware installed.</p>
*RST	<p>Resets the functional parameters of the instrument to the default settings as listed in the Factory Default Settings, see section 17.</p> <p>Does not affect the contents of the Save and Recall stores.</p> <p>Does not affect any remote interface settings.</p>
*SAV <NRF>	Save the settings for all three outputs simultaneously to the store specified by <NRF> where <NRF> can be 0-49. This includes output On/Off state, current meter averaging state, and the Multi-On/Multi-Off settings.
*RCL <NRF>	Recall the settings for all three outputs simultaneously from the store specified by <NRF> where <NRF> can be 0-49. This includes output On/Off state, current meter averaging state, and the Multi-On/Multi-Off settings.

*OPC	Sets the Operation Complete bit (bit 0) in the Standard Event Status Register. This will happen immediately the command is executed because of the sequential nature of all operations.
*OPC?	Query Operation Complete status. The response is always 1<RMT> and is available immediately the command is executed because all commands are sequential.
*WAI	Wait for Operation Complete true. This command does nothing because all operations are sequential.
*TST?	The product has no self-test capability and the response is always 0<RMT>.
*TRG	The product has no trigger capability. The command is ignored in this instrument.

### 14.2.3 Status Commands

*CLS	Clear Status. Clears all status indications, including the Status Byte. Does not clear any Enable Registers.
LSR<N>?	Query and clear the Limit Status Register<N>. The response format is <NR1><RMT>. See Status Reporting section for details of the response.
LSE<N> <NRF>	Set the Limit Status Enable Register<N> to <NRF>
LSE<N>?	Returns the value in the value in the Limit Status Enable Register<N>. The response format is<NR1><RMT>.
EER?	Query and clear Execution Error Register. The response format is <NR1><RMT>.
QER?	Query and clear Query Error Register. The response format is <NR1><RMT>.
*STB?	Report the value of the Status Byte. The response is: <NR1><RMT>. Because there is no output queue, MAV can only be read by a GPIB (optional) serial poll, not by this query, as any previous message must have already been sent.
*SRE <NRF>	Sets the Service Request Enable Register to <NRF>
*SRE?	Report the value in the Service Request Enable Register. The response is <NR1><RMT>.
*PRE <NRF>	Set the Parallel Poll Enable Register to the value <NRF>.
*PRE?	Report the value in the Parallel Poll Enable Register. The response is <NR1><RMT>.
*IST?	Returns the state of the <b>ist</b> local message as defined by IEEE Std. 488.2. The response is 0<RMT> if the local message is false, or 1<RMT> if true.

## 14.2.4 Interface Management Commands

LOCAL	Go to local. Any subsequent command will restore the remote state.
IFLOCK <NRF>	Set or Clear the lock requiring the instrument to respond only to this interface, where <NRF> has the meaning: 0 = clear and 1 = set the lock. It is an Execution Error (number 200) if the request is denied either because of conflict with a lock on this or another interface, or the user has disabled this interface from taking control using the web interface.
IFLOCK?	Query the status of the interface lock. The response is: <NR1><RMT> where <NR1> is = 0 if there is no active lock, = 1 if this interface instance owns the lock or = -1 if the lock is unavailable either because it is in use by another interface or the user has disabled this interface from taking control (via the web interface).
ADDRESS?	Returns the GPIB (optional) bus Address. The response is <NR1><RMT>.
IPADDR?	Returns the present IP address of the LAN interface, provided it is connected. If it is not connected, the response will be the static IP if configured to always use that static IP, otherwise it will be 0.0.0.0 if waiting for DHCP or Auto-IP. The response is nnn.nnn.nnn.nnn<RMT>, where each nnn is 0 to 255.
NETMASK?	Returns the present netmask of the LAN interface, provided it is connected. The response is nnn.nnn.nnn.nnn<RMT>, where each nnn is 0 to 255.
NETCONFIG?	Returns the first means by which an IP address will be sought. The response is <CRD><RMT> where <CRD> is DHCP, AUTO or STATIC.

The following commands specify the parameters to be used by the LAN interface. **Note:** a power cycle is required after these commands are sent before the new settings are used (or returned in response to the queries listed above). The instrument does not attempt to check the validity of the IP address or netmask in any way other than checking that each part fits in 8 bits. The rear panel LAN RESET switch will override these commands and restore the defaults as described earlier.

NETCONFIG <CPD>	Specifies the first means by which an IP address will be sought. <CPD> must be one of DHCP, AUTO or STATIC.
IPADDR <QUAD>	Sets the potential static IP address of the LAN interface (as on the webpage). The parameter must be strictly a dotted quad for the IP address, with each address part an <NR1> in the range 0 to 255, (e.g. 192.168.1.101).
NETMASK <QUAD>	Sets the netmask to accompany the static IP address of the LAN interface. The parameter must be strictly a dotted quad for the netmask, with each part an <NR1> in the range 0 to 255, (e.g. 255.255.255.0).



---

## 15 Maintenance

The Manufacturers or their agents overseas will provide a repair service for any unit developing a fault. Where owners wish to undertake their own maintenance work, this should only be done by skilled personnel in conjunction with the Service Guide, which may be purchased directly from the Manufacturers or their agents overseas.

### 15.1 Cleaning

If the instrument requires cleaning use a cloth that is only lightly dampened with water or a mild detergent.

**WARNING! TO AVOID ELECTRIC SHOCK, OR DAMAGE TO THE INSTRUMENT,  
NEVER ALLOW WATER TO GET INSIDE THE CASE.  
TO AVOID DAMAGE TO THE CASE NEVER CLEAN WITH SOLVENTS.**

### 15.2 Fuse

The correct fuse type is:

**10 Amp 250V HBC time-lag (T), 5 x 20mm**

Make sure that only fuses of the required rated current and specified type are used for replacement. The use of makeshift fuses and the short-circuiting of fuse-holders is prohibited.

To replace the fuse, first disconnect the instrument from the AC supply. Remove the 2 cover securing screws at the rear and slide back and lift off the cover. Replace the fuse with one of the correct type and refit the cover.

Note that the main function of the fuse is to make the instrument safe and limit damage in the event of failure of one of the switching devices. If a fuse fails it is therefore very likely that the replacement will also blow, because the supply has developed a fault; in such circumstances the instrument will need to be returned to the manufacturer for service.

### 15.3 Calibration

To ensure that the accuracy of the instrument remains within specification the calibration must be checked (and if necessary adjusted) annually. The procedure is detailed in the Service Guide, which also lists the calibrated test equipment required.

### 15.4 Firmware Update

The firmware of the instrument can be updated through the USB port using a PC software utility available from the manufacturer. This uses a HID (human interface device) USB class driver which will already be installed on any PC with a USB port. Instructions for the update procedure are provided with the PC utility and the firmware file.

## 16 Technical Specifications

General specifications apply for the temperature range 5°C to 40°C. Accuracy specifications apply for the temperature range 18°C to 28°C after 15 minutes warm-up with no load and calibration at 23°C. Typical specifications are determined by design and are not guaranteed.

### OUTPUT SPECIFICATIONS (Each Output)

Voltage/Current Ranges:	O/P1: Switchable 0V to 35V/0.1mA to 3A or 0V to 16V/0.1mA to 6A O/P2: 0V to 35V/1mA to 3A, 0V to 16V/1mA to 6A or 0V to 35V/1mA to 6A with O/P3 disabled. O/P3: 0V to 35V/1mA to 3A, 0V to 70V/1mA to 1.5A or 0V to 70V/1mA to 3A with O/P2 disabled
Output Power:	Up to 315W total output power
Voltage Setting:	Resolution: 1mV O/P1; 10mV O/P2 and O/P3 Accuracy: O/P1: 0.05% of setting $\pm$ 3mV, O/P2 and O/P3: 0.1% of setting $\pm$ 10mV
Current Setting:	Resolution: 0.1mA O/P1; 1mA O/P2 and O/P3 Accuracy: $\pm$ (0.3% + 3mA) to 3A, $\pm$ (0.5% + 3mA) to 6A
Operating Mode:	Constant voltage or constant current with automatic cross-over. CV or CC mode indication in display.
Output Switch:	Independent electronic switching with ON indication. In addition, Multi-On and Multi-Off keys permit the outputs to be switched on/off synchronously.
Multi-On/Multi-Off Action:	Individually settable delay between pressing of the Multi-On or Multi-Off key and the turning on or off of the respective output. Delays settable between 10ms and 20 seconds. Separate delays for On and Off can be set. Outputs can also be omitted from Multi-On or Multi-Off control.
Output Terminals:	Universal 4mm safety binding posts on 19mm (0.75") spacing for Output; screwless terminals for Sense. MX100TP also has duplicate power and sense terminals at rear.
Ripple & Noise (20MHz bandwidth):	Outputs 1 and 2 loaded at 16V/6A, Output 3 loaded at 35V/3A, CV mode: All Outputs typically <0.5mVrms, <5mV pk-pk; 1mVrms max. O/P 3 on 70V/3A range: typically <1mVrms, <10mV pk-pk; 1.5mVrms max.
Load Regulation:	For any load change, measured at the output terminals, using remote sense: Constant voltage: <0.01% $\pm$ 5mV Constant current: < 0.01% $\pm$ 0.5mA
Line Regulation:	Change in output for a 10% line change: Constant voltage: <0.01% $\pm$ 5mV Constant current: < 0.01% $\pm$ 250uA
Transient Response:	<100us to within 50mV of set level for a 5% to 95% load change.
Temp. Coefficient:	Typically <100ppm/°C
Voltage Programming Speed MX100TP only: (Typical figures)	Maximum time required for output to settle within 1% of its total excursion (for resistive load). Excludes command processing time.

		90% Load	No Load		90% Load	No Load
35V 3A	Up	10ms	10ms	Down	60ms	550ms
16V 6A	Up	10ms	10ms	Down	10ms	350ms
70V 3A	Up	25ms	12ms	Down	80ms	850ms
35V 6A	Up	10ms	10ms	Down	20ms	550ms

Output Protection:	Output will withstand an applied forward voltage of up to 50V (O/P1 and O/P2), or 80V O/P3. Reverse protection by diode clamp for reverse currents up to 3A.
Over-voltage Protection (OVP) Trip:	Outputs 1 and 2: 1V to 40V. Output 3: 1V to 80V. Output trips off for OVP. Resolution 100mV. Response time: typically 500us. Accuracy: $\pm (2\% \pm 0.5V)$
Over-current Protection (OCP) Trip:	Measure-and-compare over-current protection is implemented in firmware. Output trips off for OCP. Setting resolution: 10mA. Response time: typically 500ms. Accuracy: $\pm (0.3\% \pm 2\text{digits})$
Over-temperature Protection (OTP) Trip:	The output will be tripped off if a fault or blocked ventilation causes the internal temperature to rise excessively.

## METER SPECIFICATIONS (Each Output)

Voltage/Current Meters	5 digit meters for O/P 1; 4 digit meters for O/P 2 and O/P 3.
Voltage	Resolution: O/P1: 1mV; O/P2 and O/P3: 10mV Accuracy: 0.1% of reading $\pm 2$ digits
Current	Resolution: O/P1: 0.1mA; O/P2 and O/P3: 1mA Accuracy: 0.3% of reading $\pm 2$ digits
Current Meter Averaging V x A:	User selectable On/Off per output with High, Medium or Low settings O/P1: 5-digits. Resolution 0.001W to 100W, 0.01W above 100W. O/P2 and O/P3: 5-digits. Resolution 0.01W. Accuracy: 0.5% of reading $\pm 3$ digits

## SETTING MEMORY STORES

Stores for Individual Outputs:	50 store positions for each output. Values stored are Range, Voltage, Current, OVP and OCP
Stores for All Outputs:	50 store positions operating on all three outputs simultaneously. Values stored are Range, Voltage, Current, OVP, OCP, Output On/Off, Current Meter Averaging, Multi-On/Multi-Off Setup

## USER INTERFACE

Display:	Black on white backlit graphic LCD, 256 x 112 pixels. Multiple font sizes and graphic icons.
Soft Keys:	Six illuminated multi-function keys annotated from the display.
Home Screen:	Simultaneous display of meters and settings for all outputs. Direct access to voltage or current setting for any output.
Individual Screens:	Display of meters and extended settings for an individual output (meters in larger font). Direct access for all settings for that output.
Numeric Setting:	Floating point numeric entry of voltage, current, OVP or OCP.
Spin Wheel Setting:	Voltage, current and other parameters can be adjusted using the spin wheel in quasi-analog fashion. Wheel can be disabled.
Menu Screen	System level functions are selected from a scrollable list.
Help Text	Multi-page help text is available for system level functions.
Front Panel Locking:	The lock key can be used to disable front panel control (hold to unlock). If required locking can alternatively be done using a secure passcode.

## INTERFACES (MX100TP only)

Full digital remote control facilities are available through the USB, RS232, LAN and GPIB (optional) interfaces. Setting and readback resolutions are the same as for the Output and Meter specifications respectively.

RS232:	Standard 9-pin D-connector. Baud rate 9600.
USB:	Standard USB 2.0 hardware connection.
LAN:	Ethernet 100/10base-T hardware connection. 1.4 LXI Core 2011.
GPIB (optional):	Conforms with IEEE488.1 and IEEE488.2.
Remote Command Processing Time:	Typically, 120ms (80ms min, 160ms max) between receiving the command terminator for a step voltage change at the instrument and the output voltage beginning to change.

## GENERAL

AC Input:	115V – 240V AC $\pm$ 10%, 50/60Hz. Installation Category II.
Power Consumption:	500VA max.
Operating Range:	+5°C to +40°C, 20% to 80% RH.
Storage Range:	–40°C to + 70°C.
Environmental:	Indoor use at altitudes up to 2000m, Pollution Degree 2.
Safety & EMC:	Complies with EN61010-1 & EN61326-1. For details, request the EU Declaration of Conformity for this instrument via <a href="http://www.aimtti.com/support">http://www.aimtti.com/support</a> (serial no. needed).
Size:	210 x 130 x 375mm (WxHxD) half rack width x 3U height.
Weight:	4.9kg
Options:	19-inch rack kit for one or two units.

---

## 17 Default Values

When supplied from the factory the power supply is set as follows:

### All Outputs

Voltage	1 volt
Current	0.1 amp
Range	35V/3A
OVP	40V (O/P1 and O/P2); 80V (O/P3)
OCP	7A (O/P1 and O/P2); 3.5A (O/P3)
Current meter averaging	Off (Level = Medium)
Voltage tracking	None
Output On/Off	Off
Multi On/Off action	All Quick (synchronous on, synchronous off)

### System Level Settings

Power-up state	Settings as at power-down, all outputs off
Beep sound	Enabled for key errors and trips Disabled for entry into CC mode
Spin wheel action	Normal

The default values can be restored from the “Reset to factory Defaults” function – see section [10.7](#).



**Thurlby Thandar Instruments Ltd.**

Glebe Road • Huntingdon • Cambridgeshire • PE29 7DR • England (United Kingdom)

Telephone: +44 (0)1480 412451 • Fax: +44 (0)1480 450409

International web site: [www.aimtti.com](http://www.aimtti.com) • UK web site: [www.aimtti.co.uk](http://www.aimtti.co.uk) • USA web site: [www.aimtti.us](http://www.aimtti.us)

Email: [info@aimtti.com](mailto:info@aimtti.com)